

VAN STORAGE SOLUTIONS



UNMATCHED SECURITY & DURABILITY



Editors' Choice Award  
for Best New Product or Innovation!



WWW.WEATHERGUARD.COM

THE NEXT GENERATION OF VAN STORAGE.

# REDZONE

Our totally rethought and redesigned van platform puts you in the position to score maximum productivity, no matter what your trade is.

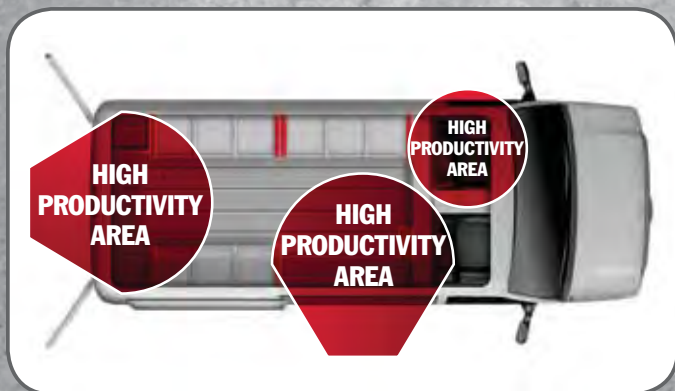

The REDZONE is all about productivity and organization. Get your van work ready with WEATHER GUARD® REDZONE Pro Packages.

THESE CHANGES ARE SO BIG, YOU'LL NEED A VAN TO PUT THEM IN! SO, JOIN US IN THE REDZONE. IT'S WHERE THE WINNERS WORK.



# WELCOME TO THE

# ONE



## TABLE OF CONTENTS

<b>NEW PRODUCTS .....</b>	<b>4-5</b>
<b>VAN CONFIGURATOR .....</b>	<b>6-7</b>
<b>PRO PACKAGES.....</b>	<b>8-15</b>
Chevy Express/GMC Savana .....	10
Ford E-Series .....	11
PROMASTER .....	12
Sprinter .....	13
Transit Connect.....	14
Nissan NV.....	15
<b>BULKHEADS .....</b>	<b>16-19</b>
Bulkhead Accessories .....	18
Full-Size Van Bulkheads .....	19
High-Roof Van Bulkheads.....	19
Compact Van Bulkheads .....	19
<b>SHELVING .....</b>	<b>20-25</b>
REDZONE Shelving .....	22
Shelving Selection Guide.....	23
Secure Storage.....	24
Welded EZ Cube Shelving .....	25
<b>REDZONE ACCESSORIES .....</b>	<b>26-33</b>
Accessories .....	28-33
<b>SPECIALTY STORAGE.....</b>	<b>34-39</b>
PACK RAT® Drawer Units .....	36-37
ITEMIZER® Drawer Units.....	38
BED RAT® Sliding Platform .....	39
<b>ROOF RACKS .....</b>	<b>40-47</b>
EZ-GLIDE® System Racks .....	42-43
Rack Accessories .....	43
Quick Clamp Racks.....	44-45
All-Purpose Racks.....	46
Safari Rack .....	47
Sliding Ladder Rack .....	47
<b>FITTING GUIDES.....</b>	<b>48-50</b>
Vehicle Fitting Guide.....	48-49
Roof Rack Fitting Guide.....	50
<b>PART NUMBER REFERENCE GUIDE .....</b>	<b>51</b>

# RED, WHITE & NEW

## REDZONE ACCESSORIES

REDZONE Accessories help you put frequently used **tools and materials** close, where you need them – including a tool organizer, cleaning station, wire spool holder, caulk tube tray, a range of **trade-specific accessories**, and more



## SHELVING

**REDZONE Van Shelving** has **deeper widths** to fit large tool cases, floor notches to fit wide supplies or PACK RAT® Drawer Units, red end-panel caps to secure loads, optional cam handle **tool-less adjustable** shelves, and many other fast installation features

WEATHER GUARD® Van Solutions are ready to roll with game changing improvements based on years of research and your input. Completely retooled shelving, improved bulkheads, customizable organizational features, and a host of smart new accessories, designed around the common sense idea that tools and equipment belong on the shelf, not the floor. Our new WEATHER GUARD® Van Solutions catalog has all the details. Here are some of the highlights!

# TOTALLY NEW VAN STORAGE SOLUTIONS. FOR THE WAY YOU WORK™

## BETTER BULKHEADS

Better bulkheads with **polycarbonate windows** and tighter fit for visibility, noise reduction, and **climate control**; simplified mounting brackets; and our exclusive **Dog Hatch™ door**

## SPECIALTY STORAGE

Specialty Storage with new Secure Storage **locking cabinets** and drawers, a new roll-out **tool drawer**, new **Grab & Go tool cart**, and more

## QUICK INSTALLATION

**Quick installation** features from floor mounting brackets to simplified bulkhead mounting brackets, and **pre-punched mounting holes** in end panels and shelves

**The WEATHER GUARD® Promise** What hasn't changed is our commitment to quality. Shelving, cabinets, drawers, and end panels built with heavy-duty 18-gauge steel for unmatched durability. ARMOR TUF® Brite White Powder Coat finish for years of worry-free service. All WEATHER GUARD® Van Solutions are backed by our exclusive, Limited Lifetime Warranty.

## GRAB & GO TOOL CART



# CUSTOM CONFIGURATION



# YOUR VAN, YOUR PLAN.

## ATOR

### CUSTOMIZING YOUR VEHICLE IS AS EASY AS 1-2-3:

1. Choose your make & model
2. Select a base package
3. Customize & add accessories

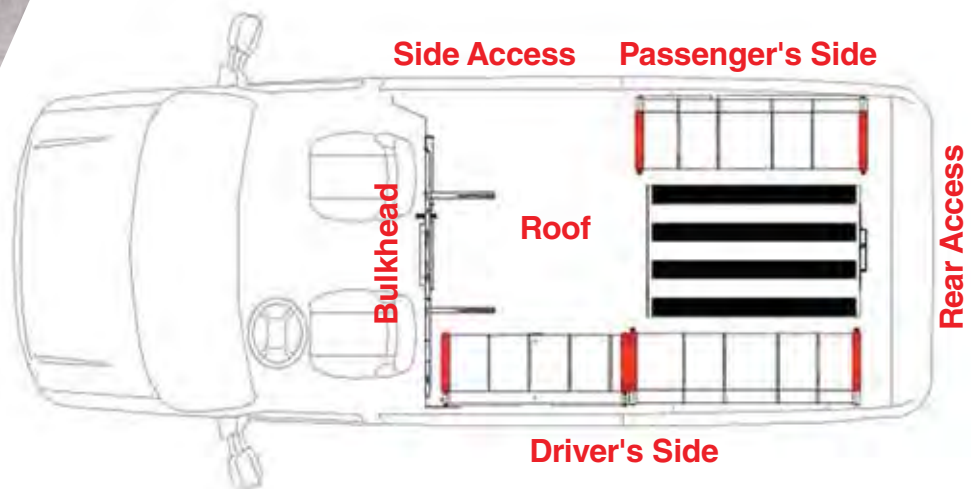

- Wide selection of vehicles with pre-built custom packages
- Printable design drawings and parts list
- Referral to local distributor for quote and installation

To get started, visit [www.wgconfigurator.com](http://www.wgconfigurator.com)

# PRO PACKAGES







**MORE THAN EVER, TIME IS MONEY. SO WEATHER GUARD® VAN SOLUTIONS HAS RE-ENGINEERED TIME-SAVING VAN STORAGE PACKAGES FOR A BROAD RANGE OF PROFESSIONAL TRADES.**

- Packages for General Contractors, Plumbing, Electrical, HVAC, Telecom, Security and more
- Complete combinations of shelving, bulkheads, and cabinets
- Specialized accessories selected for specific job requirements
- Packages for all commercial Full-Size, High-Roof, and Compact Vans

# CHEVY EXPRESS / GMC SAVANA

USE THESE PACKAGES ON FULL SIZE FORD VANS TOO

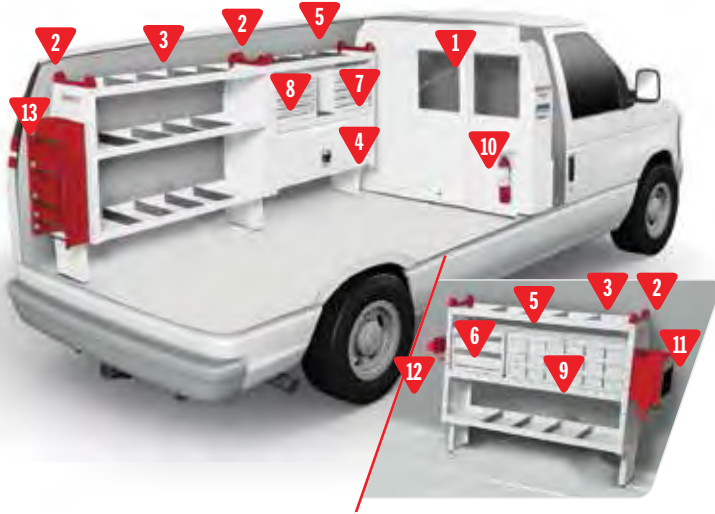

## Contractor / Remodeler 600-9101

MODEL	DESCRIPTION	QUANTITY
1	96101-3-01 Window Bulkhead for Full Size Vans	1
2	9264-3-01 End Panel Pair, 16"x46"	3
3	9185-3-01 Van Shelf Set, 3 shelves 52"x16"	2
4	9040-3-01 Lockable Secure Storage Module 42"x17"x16"	1
5	9992-3-01 Van top shelf for Secure Storage shelf units, 42"x13"	1
6	9912-3-01 2 Drawer Cabinet 16"x14"x12"	1
7	9914-3-01 4 Drawer Cabinet 16"x14"x12"	1
8	9909-3-01 Parts Cabinet 9 Bin 16"x12"x12"	1
9	9918-3-01 Parts Cabinet 18 Bin 32"x12"x12"	1
10	8866 Fire Extinguisher	1
11	9878-7-01 REDZONE Cleaning Station	1
12	9881-7-01 REDZONE Caulk Tube Tray	1
13	9882-7-01 REDZONE Wire Spool Holder End Mount	1

▼ 209-3 2 Crossmember Rack

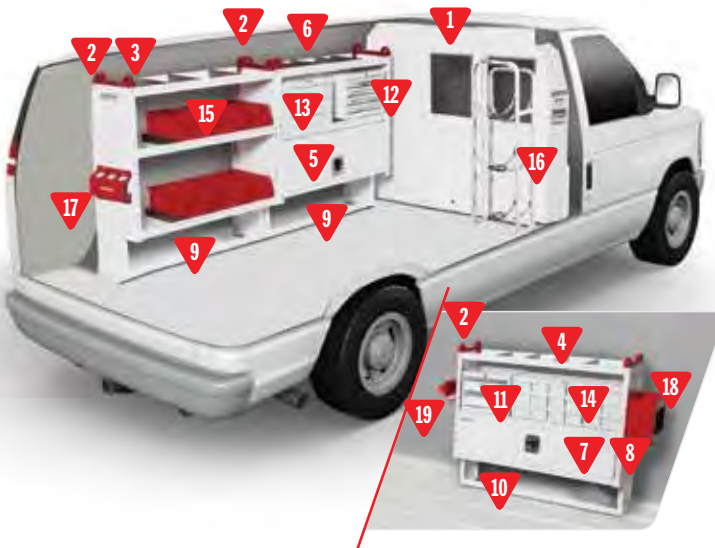

## Mechanical Contractor / HVAC 600-9103

MODEL	DESCRIPTION	QUANTITY
1	96101-3-01 Window Bulkhead for Full Size Vans	1
2	9264-3-01 End Panel Pair, 16"x46"	3
3	9184-3-01 Van Shelf Set, 3 shelves 42"x16"	1
4	9185-3-01 Van Shelf Set, 3 shelves 52"x16"	1
5	9040-3-01 Lockable Secure Storage Module 42"x17"x16"	1
6	9992-3-01 Van top shelf for Secure Storage shelf units, 42"x13"	1
7	9505-3-01 Shelf Door, 52"	1
8	9605-3-01 Accessory Back Panel, 52"	1
9	9704-3-01 Retainer Lip, 42"	2
10	9705-3-01 Retainer Lip, 52"	1
11	9912-3-01 2 Drawer Cabinet 16"x14"x12"	1
12	9914-3-01 4 Drawer Cabinet 16"x14"x12"	1
13	9909-3-01 Parts Cabinet 9 Bin 16"x12"x12"	1
14	9918-3-01 Parts Cabinet 18 Bin 32"x12"x12"	1
15	9855-7-01 REDZONE Medium Bin Set	1
16	9862-3-01 Refrigerant Tank Rack 3x30#	1
17	9874-7-01 REDZONE Can Organizer	1
18	9878-7-01 REDZONE Cleaning Station	1
19	9881-7-01 REDZONE Caulk Tube Tray	1

▼ 216-3 All-Purpose Van Rack

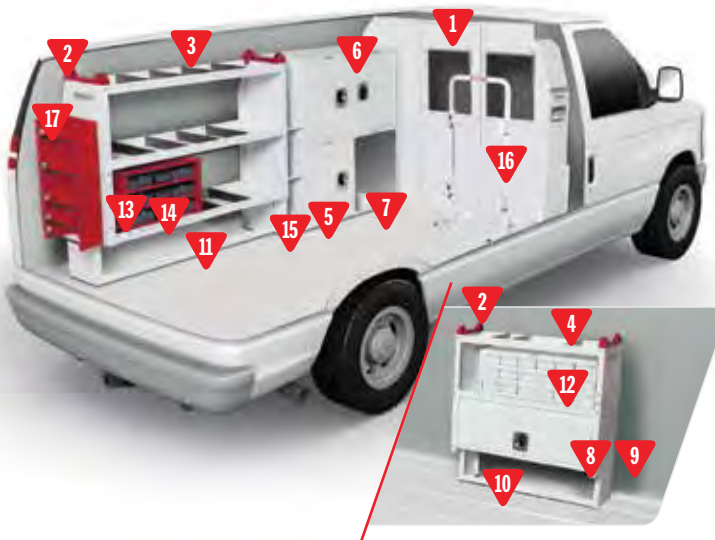

## Telecom / Security 600-9105

MODEL	DESCRIPTION	QUANTITY
1	96101-3-01 Window Bulkhead for Full Size Vans	1
2	9264-3-01 End Panel Pair, 16"x46"	2
3	9185-3-01 Van Shelf Set, 3 shelves 52"x16"	1
4	9194-3-01 Van Shelf Set, 3 shelves 42"x16"	1
5	9020-3-01 Lockable Cabinet, no shelf 22"x18"x16"	1
6	9021-3-01 Lockable Cabinet, 1 shelf 22"x18"x16"	2
7	9029-3-01 Cabinet Base, with bin 22"x18"x16"	1
8	9504-3-01 Shelf Door, 42"	1
9	9604-3-01 Accessory Back Panel, 42"	1
10	9704-3-01 Retainer Lip, 42"	1
11	9705-3-01 Retainer Lip, 52"	1
12	9918-3-01 Parts Cabinet 18 Bin 32"x12"x12"	1
13	9950-7-01 Parts Box Cabinet 20"x14"x13"	1
14	9951-9-01 Parts Box, adj compartments 18"x13"x3"	3
15	9860-3-01 Catalog File Unit, 6"x36"x12"	1
16	9861-3-01 Cable Reel Holder Floor Mount	1
17	9882-7-01 REDZONE Wire Spool Holder End Mount	1

▼ 234-3-01 Dual Quick Clamp Van Rack



More packages online at [www.weatherguard.com](http://www.weatherguard.com)

# FORD E-SERIES

USE THESE PACKAGES ON FULL SIZE GM VANS TOO

! RECOMMENDED LADDER RACK

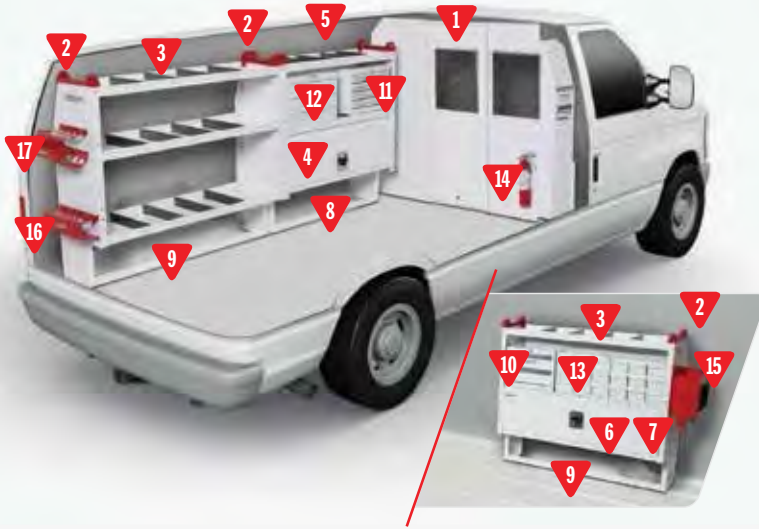

## Plumber 600-9102

MODEL	DESCRIPTION	QUANTITY
1	96101-3-01 Window Bulkhead for Full Size Vans	1
2	9264-3-01 End Panel Pair, 16"x46"	3
3	9185-3-01 Van Shelf Set, 3 shelves 52"x16"	2
4	9040-3-01 Lockable Secure Storage Module 42"x17"x16"	1
5	9992-3-01 Van top shelf for Secure Storage shelf units, 42"x13"	1
6	9505-3-01 Shelf Door, 52"	1
7	9605-3-01 Accessory Back Panel, 52"	1
8	9704-3-01 Retainer Lip, 42"	1
9	9705-3-01 Retainer Lip, 52"	2
10	9912-3-01 2 Drawer Cabinet 16"x14"x12"	1
11	9914-3-01 4 Drawer Cabinet 16"x14"x12"	1
12	9909-3-01 Parts Cabinet 9 Bin 16"x12"x12"	1
13	9918-3-01 Parts Cabinet 18 Bin 32"x12"x12"	1
14	8866 Fire Extinguisher	1
15	9878-7-01 REDZONE Cleaning Station	1
16	9879-7-01 REDZONE Tool Organizer	1
17	9881-7-01 REDZONE Caulk Tube Tray	1

! 216-3 All-Purpose Van Rack

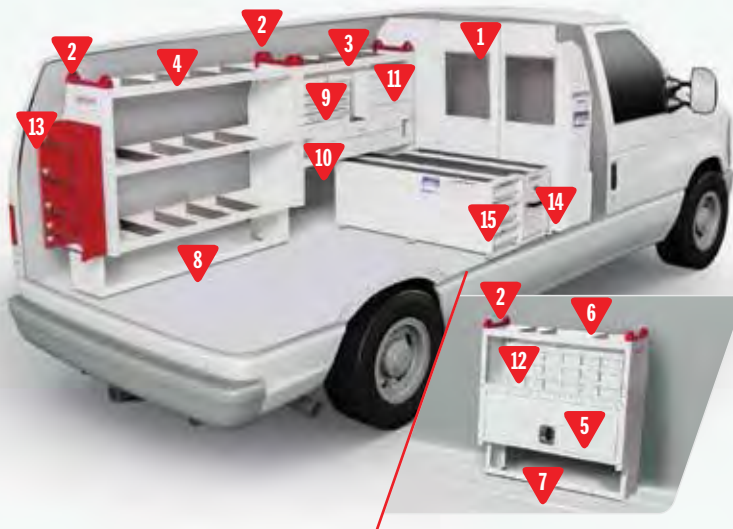

## Electrician / Electrical Contractor 600-9104

MODEL	DESCRIPTION	QUANTITY
1	96101-3-01 Window Bulkhead for Full Size Vans	1
2	9264-3-01 End Panel Pair, 16"x46"	3
3	9184-3-01 Van Shelf Set, 3 shelves 42"x16"	1
4	9185-3-01 Van Shelf Set, 3 shelves 52"x16"	1
5	9040-3-01 Lockable Secure Storage Module 42"x17"x16"	1
6	9992-3-01 Van top shelf for Secure Storage shelf units, 42"x13"	1
7	9704-3-01 Retainer Lip, 42"	1
8	9705-3-01 Retainer Lip, 52"	1
9	9914-3-01 4 Drawer Cabinet 16"x14"x12"	1
10	9906-3-01 Parts Cabinet 6 Bins 32"x12"x4"	1
11	9909-3-01 Parts Cabinet 9 Bin 16"x12"x12"	1
12	9918-3-01 Parts Cabinet 18 Bin 32"x12"x12"	1
13	9882-7-01 REDZONE Wire Spool Holder End Mount	1
14	310-3-01 PACK RAT® Drawer Unit 12"x42"x17"	1
15	327-3 ITEMIZER® Drawer Unit	1

! 234-3-01 Dual Quick Clamp Ladder Rack

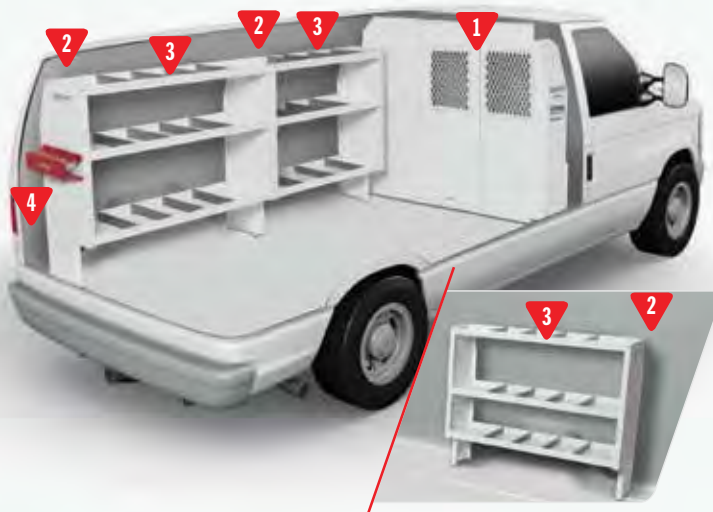

## Starter 600-8000

MODEL	DESCRIPTION	QUANTITY
1	96102-3-01 Screen Bulkhead for Full Size Vans	1
2	9204-3-01 End Panel Pair, 16"x46"	3
3	9104-3-01 Van Shelf Set, 3 shelves 42"x16"	3
4	9879-7-01 REDZONE Tool Organizer	1

! Try our NEW **Van Configurator** to customize your upfit.  
[www.wgconfigurator.com](http://www.wgconfigurator.com)

# PROMASTER



## Contractor / Remodeler

600-8241

MODEL	DESCRIPTION	QUANTITY
1	96142-3-01 Screen Bulkhead for RAM Promaster	1
2	9266-3-01 End Panel Pair, 16"x62"	3
3	9195-3-01 Van Shelf Set, 4 shelves 52"x16"	1
4	9196-3-01 Van Shelf Set, 4 shelves 60"x16"	1
5	9045-3-01 5 Drawer Secure Storage Module 42"x17"x16"	1
6	9992-3-01 Van top shelf for Secure Storage shelf units, 42"x13"	1
7	9164-3-01 Accessory Shelf, 42"x16"	1
8	9504-3-01 Shelf Door, 42"	1
9	9604-3-01 Accessory Back Panel, 42"	1
10	9855-7-01 REDZONE Medium Bin Set	1
11	9879-7-01 REDZONE Tool Organizer	1
12	9882-7-01 REDZONE Wire Spool Holder End Mount	1

## Mechanical Contractor / HVAC

600-8243

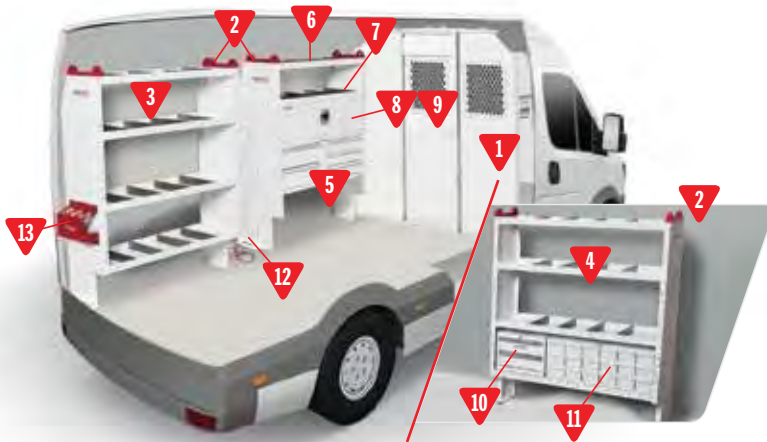

MODEL	DESCRIPTION	QUANTITY
1	96142-3-01 Screen Bulkhead for RAM Promaster	1
2	9266-3-01 End Panel Pair, 16"x62"	3
3	9194-3-01 Van Shelf Set, 4 shelves 42"x16"	1
4	9195-3-01 Van Shelf Set, 4 shelves 52"x16"	1
5	9045-3-01 5 Drawer Secure Storage Module 42"x17"x16"	1
6	9992-3-01 Van top shelf for Secure Storage shelf units, 42"x13"	1
7	9164-3-01 Accessory Shelf, 42"x16"	1
8	9504-3-01 Shelf Door, 42"	1
9	9604-3-01 Accessory Back Panel, 42"	1
10	9912-3-01 2 Drawer Cabinet 16"x14"x12"	1
11	9918-3-01 Parts Cabinet 18 Bin 32"x12"x12"	1
12	9864-3-01 Refrigerant Tank Rack 4x30#	1
13	9874-7-01 REDZONE Can Organizer	1

## Electrician / Electrical Contractor

600-8244

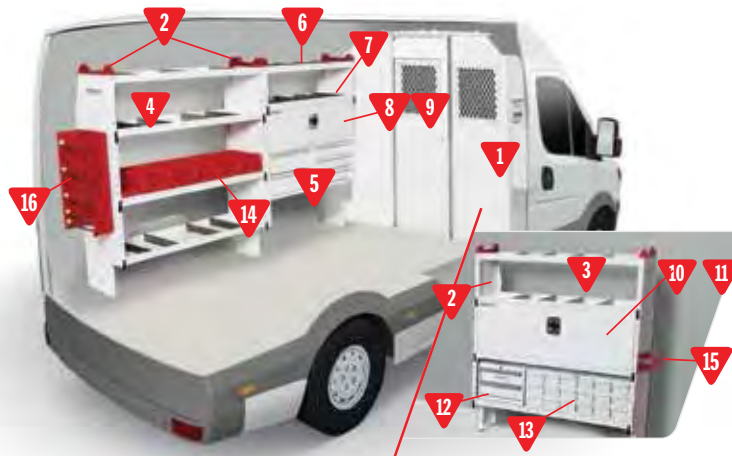

MODEL	DESCRIPTION	QUANTITY
1	96142-3-01 Screen Bulkhead for RAM Promaster	1
2	9266-3-01 End Panel Pair, 16"x62"	3
3	9195-3-01 Van Shelf Set, 4 shelves 52"x16"	1
4	9196-3-01 Van Shelf Set, 4 shelves 60"x16"	1
5	9045-3-01 5 Drawer Secure Storage Module 42"x17"x16"	1
6	9992-3-01 Van top shelf for Secure Storage shelf units, 42"x13"	1
7	9164-3-01 Accessory Shelf, 42"x16"	1
8	9504-3-01 Shelf Door, 42"	1
9	9604-3-01 Accessory Back Panel, 42"	1
10	9505-3-01 Shelf Door, 52"	1
11	9605-3-01 Accessory Back Panel, 52"	1
12	9912-3-01 2 Drawer Cabinet 16"x14"x12"	1
13	9918-3-01 Parts Cabinet 18 Bin 32"x12"x12"	1
14	9855-7-01 REDZONE Medium Bin Set	1
15	9874-7-01 REDZONE Can Organizer	1
16	9882-7-01 REDZONE Wire Spool Holder End Mount	1



Try our **NEW Van Configurator** to customize your upfit.  
[www.wgconfigurator.com](http://www.wgconfigurator.com)

# SPRINTER

RECOMMENDED LADDER RACK



## Contractor / Remodeler 600-9201

MODEL	DESCRIPTION	QUANTITY
1	96121-3-01 Window Bulkhead for Sprinter	1
2	9266-3-01 End Panel Pair, 16"x62"	3
3	9195-3-01 Van Shelf Set, 4 shelves 52"x16"	1
4	9196-3-01 Van Shelf Set, 4 shelves 60"x16"	1
5	9045-3-01 5 Drawer Secure Storage Module 42"x17"x16"	1
6	9164-3-01 Accessory Shelf, 42"x16"	1
7	9992-3-01 Van top shelf for Secure Storage shelf units, 42"x13"	1
8	9504-3-01 Shelf Door, 42"	1
9	9604-3-01 Accessory Back Panel, 42"	1
10	9704-3-01 Retainer Lip, 42"	1
11	9705-3-01 Retainer Lip, 42"	1
12	9706-3-01 Retainer Lip, 60"	1
13	9912-3-01 2 Drawer Cabinet 16"x14"x12"	1
14	9918-3-01 Parts Cabinet 18 Bin 32"x12"x12"	1
15	9855-7-01 REDZONE Medium Bin Set	1
16	9878-7-01 REDZONE Cleaning Station	1
17	9879-7-01 REDZONE Tool Organizer	1
18	9882-7-01 REDZONE Wire Spool Holder End Mount	1
19	310-3-01 PACK RAT® Drawer Unit 12"x42"x17"	1

280-3-01 EZ-GLIDE® System for High Roof Vans

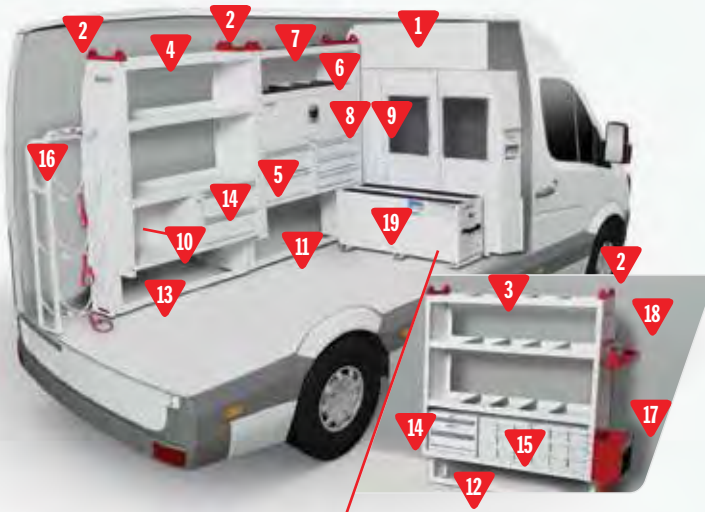

## Mechanical Contractor / HVAC 600-9203

MODEL	DESCRIPTION	QUANTITY
1	96121-3-01 Window Bulkhead for Sprinter	1
2	9266-3-01 End Panel Pair, 16"x62"	3
3	9195-3-01 Van Shelf Set, 4 shelves 52"x16"	1
4	9196-3-01 Van Shelf Set, 4 shelves 60"x16"	1
5	9045-3-01 5 Drawer Secure Storage Module 42"x17"x16"	1
6	9164-3-01 Accessory Shelf, 42"x16"	1
7	9992-3-01 Van top shelf for Secure Storage shelf units, 42"x13"	1
8	9504-3-01 Shelf Door, 42"	1
9	9604-3-01 Accessory Back Panel, 42"	1
10	9606-3-01 Accessory Back Panel, 60"	1
11	9704-3-01 Retainer Lip, 42"	1
12	9705-3-01 Retainer Lip, 42"	1
13	9706-3-01 Retainer Lip, 60"	1
14	9912-3-01 2 Drawer Cabinet 16"x14"x12"	2
15	9918-3-01 Parts Cabinet 18 Bin 32"x12"x12"	1
16	9862-3-01 Refrigerant Tank Rack 3x30#	1
17	9878-7-01 REDZONE Cleaning Station	1
18	9881-7-01 REDZONE Caulk Tube Tray	1
19	310-3-01 PACK RAT® Drawer Unit 12"x42"x17"	1

285-3-01 EZ-GLIDE® System for Standard Roof Vans

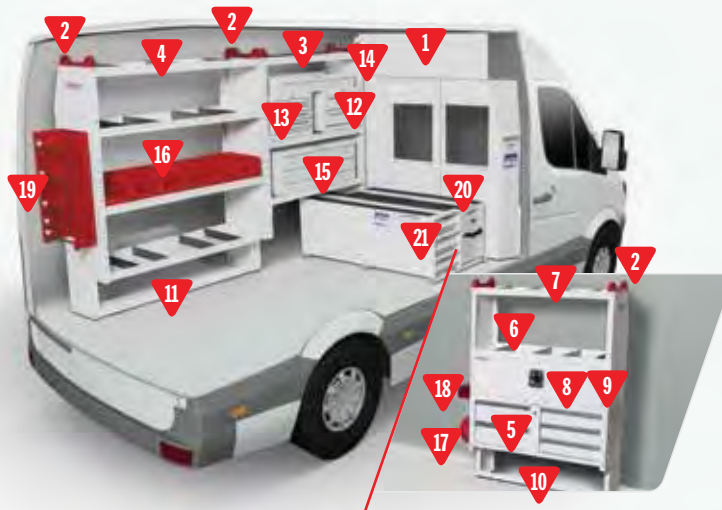

## Electrician / Electrical Contractor 600-9204

MODEL	DESCRIPTION	QUANTITY
1	96121-3-01 Window Bulkhead for Sprinter	1
2	9266-3-01 End Panel Pair, 16"x62"	3
3	9194-3-01 Van Shelf Set, 4 shelves 42"x16"	1
4	9196-3-01 Van Shelf Set, 4 shelves 60"x16"	1
5	9045-3-01 5 Drawer Secure Storage Module 42"x17"x16"	1
6	9164-3-01 Accessory Shelf, 42"x16"	1
7	9992-3-01 Van top shelf for Secure Storage shelf units, 42"x13"	1
8	9504-3-01 Shelf Door, 42"	1
9	9604-3-01 Accessory Back Panel, 42"	1
10	9704-3-01 Retainer Lip, 42"	1
11	9706-3-01 Retainer Lip, 60"	1
12	9912-3-01 2 Drawer Cabinet 16"x14"x12"	1
13	9914-3-01 4 Drawer Cabinet 16"x14"x12"	1
14	9906-3-01 Parts Cabinet 6 Bins 32"x12"x4"	1
15	9918-3-01 Parts Cabinet 18 Bin 32"x12"x12"	1
16	9855-7-01 REDZONE Medium Bin Set	1
17	8875 Hard Hat Bracket	1
18	9879-7-01 REDZONE Tool Organizer	1
19	9882-7-01 REDZONE Wire Spool Holder End Mount	1
20	310-3-01 PACK RAT® Drawer Unit 12"x42"x17"	1
21	327-3 ITEMIZER® Drawer Unit	1

# TRANSIT CONNECT

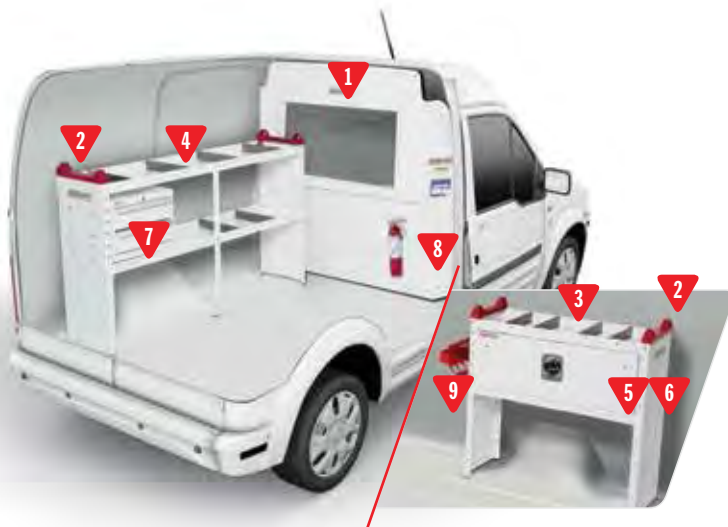

## Contractor / Remodeler 600-9301

MODEL	DESCRIPTION	QUANTITY
1	96511-3-02 Window Bulkhead for Transit Connect	1
2	9233-3-01 End Panel Pair, 13"x36"	2
3	9173-3-01 Van Shelf Set, 2 shelves 36"x13"	1
4	9176-3-01 Van Shelf Set, 2 shelves 60"x13"	1
5	9503-3-01 Shelf Door, 36"	1
6	9603-3-01 Accessory Back Panel, 36"	1
7	9912-3-01 2 Drawer Cabinet 16"x14"x12"	1
8	8866 Fire Extinguisher	1

! 218-3 All Purpose Van Rack  
226-3-01 Mounting Kit Recommended

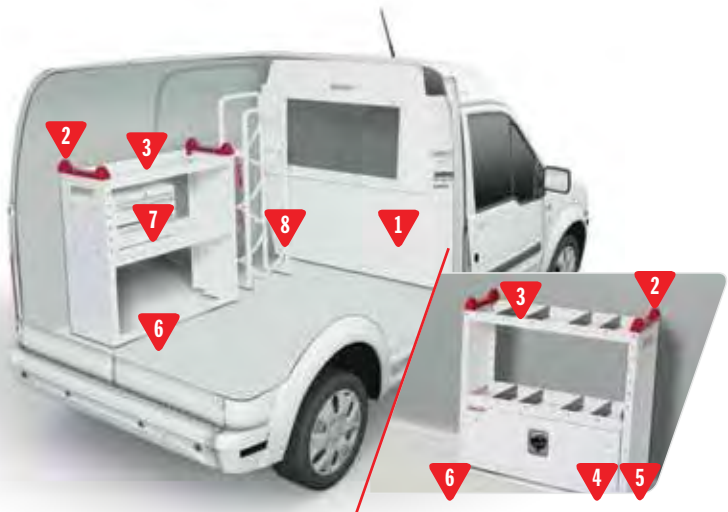

## Mechanical Contractor / HVAC 600-9303

MODEL	DESCRIPTION	QUANTITY
1	96511-3-02 Window Bulkhead for Transit Connect	1
2	9233-3-01 End Panel Pair, 13"x36"	2
3	9173-3-01 Van Shelf Set, 2 shelves 36"x13"	2
4	9503-3-01 Shelf Door, 36"	1
5	9603-3-01 Accessory Back Panel, 36"	1
6	9703-3-01 Retainer Lip, 36"	2
7	9912-3-01 2 Drawer Cabinet 16"x14"x12"	1
8	9862-3-01 Refrigerant Tank Rack 3x30#	1

! 218-3 All Purpose Van Rack  
226-3-01 Mounting Kit Recommended

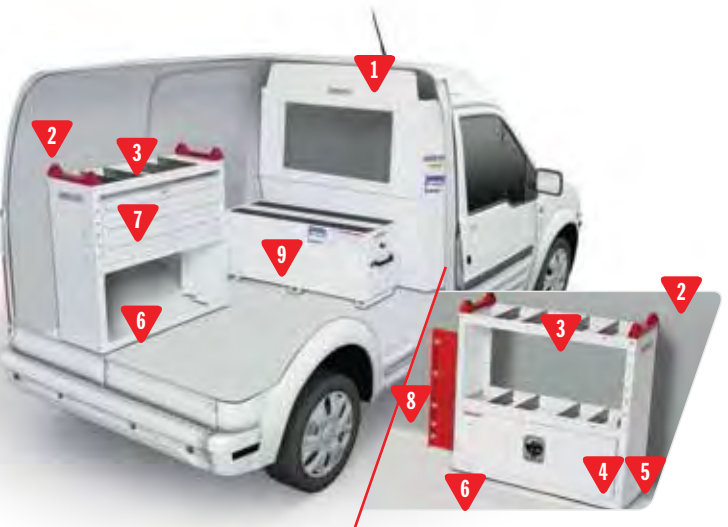

## Electrician / Electrical Contractor 600-9304

MODEL	DESCRIPTION	QUANTITY
1	96511-3-02 Window Bulkhead for Transit Connect	1
2	9233-3-01 End Panel Pair, 13"x36"	2
3	9173-3-01 Van Shelf Set, 2 shelves 36"x13"	2
4	9503-3-01 Shelf Door, 36"	1
5	9603-3-01 Accessory Back Panel, 36"	1
6	9703-3-01 Retainer Lip, 36"	2
7	9918-3-01 Parts Cabinet 18 Bin 32"x12"x12"	1
8	9882-7-01 REDZONE Wire Spool Holder End Mount	1
9	310-3-01 PACK RAT® Drawer Unit 12"x42"x17"	1

! 224-3-01 Dual Quick Clamp Ladder Rack  
226-3-01 Mounting Kit Recommended

! 2014 Transit Connect packages coming soon on  
[www.weatherguard.com](http://www.weatherguard.com)

# NISSAN NV

! RECOMMENDED LADDER RACK

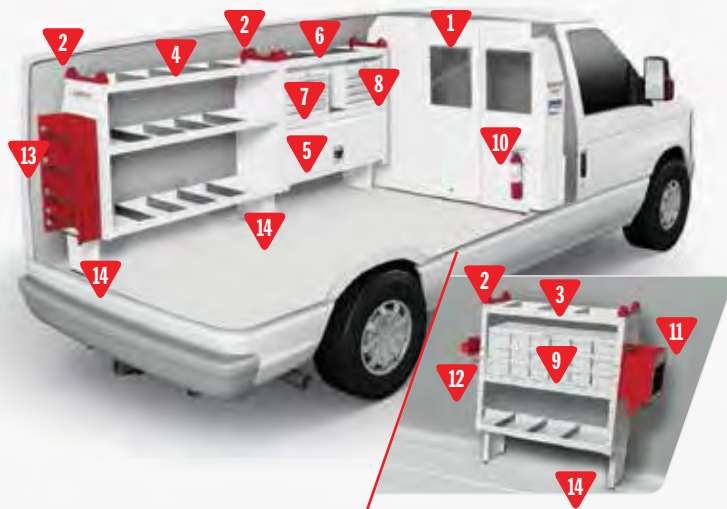

## Contractor / Remodeler

600-9131

MODEL	DESCRIPTION	QUANTITY
1	96201-3-01 Window Bulkhead for Nissan NV	1
2	9264-3-01 End Panel Pair, 16"x46"	3
3	9184-3-01 Van Shelf Set, 3 shelves 42"x16"	1
4	9185-3-01 Van Shelf Set, 3 shelves 52"x16"	1
5	9040-3-01 Lockable Secure Storage Module 42"x17"x16"	1
6	9992-3-01 Van top shelf for Secure Storage shelf units, 42"x13"	1
7	9912-3-01 2 Drawer Cabinet 16"x14"x12"	1
8	9914-3-01 4 Drawer Cabinet 16"x14"x12"	1
9	9918-3-01 Parts Cabinet 18 Bin 32"x12"x12"	1
10	8866 Fire Extinguisher	1
11	9878-7-01 REDZONE Cleaning Station	1
12	9881-7-01 REDZONE Caulk Tube Tray	1
13	9882-7-01 REDZONE Wire Spool Holder End Mount	1
14	9720-3-01 Nissan Mounting Bracket kit	3

! 285-3-01 EZ-GLIDE® System for Standard Roof Vans  
2507 Mounting Kit Required

## Mechanical Contractor / HVAC

600-9233



MODEL	DESCRIPTION	QUANTITY
1	96201-3-01 Window Bulkhead for Nissan NV	1
2	9266-3-01 End Panel Pair, 16"x62"	3
3	9194-3-01 Van Shelf Set, 4 shelves 42"x16"	2
4	9045-3-01 5 Drawer Secure Storage Module 42"x17"x16"	1
5	9164-3-01 Accessory Shelf, 42"x16"	1
6	9992-3-01 Van top shelf for Secure Storage shelf units, 42"x13"	1
7	9504-3-01 Shelf Door, 42"	1
8	9604-3-01 Accessory Back Panel, 42"	2
9	9704-3-01 Retainer Lip, 42"	3
10	9912-3-01 2 Drawer Cabinet 16"x14"x12"	1
11	9918-3-01 Parts Cabinet 18 Bin 32"x12"x12"	1
12	9862-3-01 Refrigerant Tank Rack 3x30#	1
13	9878-7-01 REDZONE Cleaning Station	1
14	9881-7-01 REDZONE Caulk Tube Tray	1
15	310-3-01 PACK RAT® Drawer Unit 12"x42"x17"	1
16	9720-3-01 Nissan Mounting Bracket kit	3

! 280-3-01 EZ-GLIDE® System for High Roof Vans  
2506 Mounting Kit Required

## Electrician / Electrical Contractor

600-9234

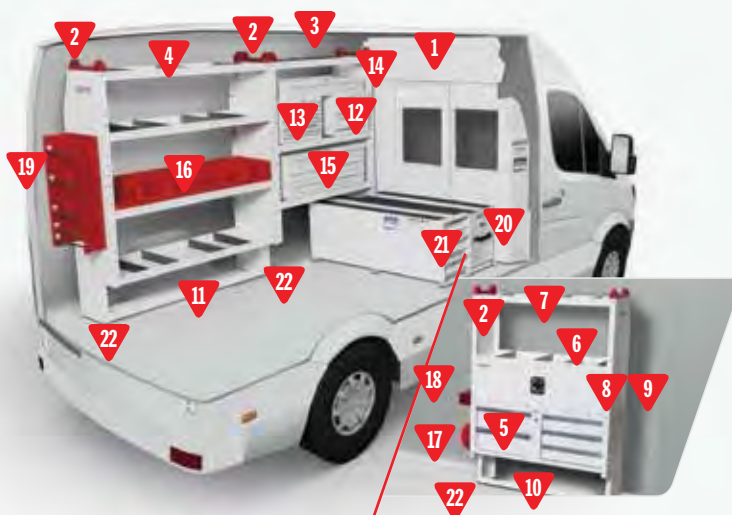

MODEL	DESCRIPTION	QUANTITY
1	96201-3-01 Window Bulkhead for Nissan NV	1
2	9266-3-01 End Panel Pair, 16"x62"	3
3	9194-3-01 Van Shelf Set, 4 shelves 42"x16"	1
4	9195-3-01 Van Shelf Set, 4 shelves 52"x16"	1
5	9045-3-01 5 Drawer Secure Storage Module 42"x17"x16"	1
6	9164-3-01 Accessory Shelf, 42"x16"	1
7	9992-3-01 Van top shelf for Secure Storage shelf units, 42"x13"	1
8	9504-3-01 Shelf Door, 42"	1
9	9604-3-01 Accessory Back Panel, 42"	1
10	9704-3-01 Retainer Lip, 42"	1
11	9705-3-01 Retainer Lip, 52"	1
12	9912-3-01 2 Drawer Cabinet 16"x14"x12"	1
13	9914-3-01 4 Drawer Cabinet 16"x14"x12"	1
14	9906-3-01 Parts Cabinet 6 Bins 32"x12"x4"	1
15	9918-3-01 Parts Cabinet 18 Bin 32"x12"x12"	1
16	9855-7-01 REDZONE Medium Bin Set	1
17	8875 Hard Hat Bracket	1
18	9879-7-01 REDZONE Tool Organizer	1
19	9882-7-01 REDZONE Wire Spool Holder End Mount	1
20	310-3-01 PACK RAT® Drawer Unit 12"x42"x17"	1
21	327-3 ITEMIZER® Drawer Unit	1
22	9720-3-01 Nissan Mounting Bracket kit	2

! 280-3-01 EZ-GLIDE® System for High Roof Vans  
2506 Mounting Kit Required

# BULKHEADS



weather guard





**CAUTION**  
 NO FUMES CAUSING EYE IRRITATION  
 NO FUMES CAUSING IRRITATION TO THE  
 CHILD SAFETY LATCH SWITCHES  
 ALL WEATHER GUARD PRODUCTS ARE  
 MADE IN THE USA

**PRODUCT REGISTRATION**

Register your **WEATHER GUARD** Product 24/7  
 Online at [www.weatherguard.com](http://www.weatherguard.com)  
 or 1-866-WTHGPRO (1-866-944-7473)

MODEL # SERIAL #

AMBER LEE  
 WEATHER GUARD

[www.weatherguard.com](http://www.weatherguard.com)  
 1-866-WTHGPRO (1-866-944-7473)

**IN AN ACCIDENT, IT'S STILL THE ONLY THING  
 STANDING BETWEEN YOU AND AN AIRBORNE  
 RECIPROCATING SAW. ONLY NOW, IT ALSO  
 CREATES A QUIETER ZONE THAT LETS YOU  
 GET THE MOST FROM YOUR MOBILE OFFICE.**

- Exclusive polycarbonate windows on all bulkheads for improved visibility and safety
- Reinforced steel end panels that fit more snugly for improved cab comfort
- Exclusive Dog Hatch™ Door for storing long materials
- Faster and easier to install with simplified mounting brackets

# BULKHEADS

Our Full-Size, High-Roof, and Compact van bulkheads allow you to separate the driver compartment from the cargo area for maximum protection against shifting loads. Exclusive polycarbonate windows improve visibility and safety. Tighter panel design ensures cabin comfort, both noise and temperature. WEATHER GUARD® Bulkheads are available for all commercial van types and sizes, from high-roof to compact. Several bulkhead accessories are available to keep you organized.

## EASY INSTALLATION

with sidewall and roof mounting brackets and pre-punched mounting holes for WEATHER GUARD® accessories

## HEAVY GAUGE STEEL

is used for strength and durability

## IMPROVED IMPACT RESISTANCE

protects you from loose objects in the cargo area



## EXCLUSIVE 9" X 12" DOG HATCH™ DOOR

allows easy loading of long materials by utilizing the floor space in front of the bulkhead



## POLYCARBONATE WINDOW BULKHEADS

allow for improved visibility, security and comfort

## PROVIDES IMPROVED HEATING AND COOLING EFFICIENCY

in the passenger area, reduces noise level, too

## NEW VERTICAL PANEL DESIGN

reduces ambient noise levels

## OPTIONAL HINGE KIT

converts bulkhead to swing door version

WEATHER GUARD® EXCLUSIVE!



## REDZONE ACCESSORIES FOR THE BULKHEAD

WEATHER GUARD® Bulkhead Accessories let you create a custom storage solution that securely organizes the items you need to locate quickly and easily.

Check out REDZONE Accessories, starting on page 26 for more details

### Bulkhead Accessories\*

MODEL	DESCRIPTION	WEIGHT
1 9879-7-01	Tool Organizer	3 lbs.
2 8875	Hard Hat Bracket	2 lbs.
3 8866	Fire Extinguisher	6 lbs.
4 8877-3	Practice Holder	4 lbs.
5 96901-3-01	Hinge Kit	4 lbs.
6 96903-3-01	Solid Panel Kit	10 lbs.





### Bulkhead for Ford & GM Full Size Vans

Offers improved visibility and a large area to mount accessories while providing safety and security for occupants and cargo.

### Bulkhead for Nissan NV Standard & High Roof

Offers extensive rear and side visibility while providing occupant protection and cargo security.

MODEL	DESCRIPTION	WEIGHT
96101-3-01	Window Bulkhead	65 lbs.
96102-3-01	Screen Bulkhead	65 lbs.
96901-3-01 (Hinge Kit)	Converts full size bulkhead to swinging door	4 lbs.

MODEL	DESCRIPTION	WEIGHT
96201-3-01	Nissan NV Window Bulkhead Includes extension panel for high roof vans.	70 lbs.
96901-3-01 (Hinge Kit)	Converts Nissan NV <b>High Roof</b> bulkhead to swinging door	4 lbs.



### Bulkhead for Sprinter Standard & High Roof

Offers improved visibility and a large area for accessory mounts and holders while providing safety and security for occupants and cargo. Includes header panels for standard and high roof vans.

### Bulkhead for Compact Vans

Window bulkheads offer unobstructed visibility of the cargo area, side door, and rear door. Maximizes comfort in the passenger area. Lightweight mesh bulkheads deliver full driver and cargo protection.

MODEL	DESCRIPTION	WEIGHT
96121-3-01	Sprinter Window Bulkhead	105 lbs.
96141-3-01	PROMASTER Window Bulkhead	105 lbs.
96142-3-01	PROMASTER Screen Bulkhead	105 lbs.
96901-3-01 (Hinge Kit)	Converts full size or high roof bulkheads to swinging door	4 lbs.

MODEL	DESCRIPTION	WEIGHT
96511-3-02	Transit Connect Window Bulkhead**	40 lbs.
96111-3-02	Transit Connect Screen Bulkhead	35 lbs.
96115-3-01	RAM C/V Tradesman Screen Bulkhead	35 lbs.
96515-3-01	RAM C/V Tradesman Window Bulkhead	40 lbs.

\*\*Ford Transit Connect (2010 - 2013 model years) use -01 instead of -02

# SHELVING





**YOU SHOULDN'T HAVE TO STRUGGLE—OR EVEN THINK—WHEN USING VAN SHELVING. THAT'S WHY WE COMPLETELY OVERHAULLED THE DESIGN TO SYNC WITH THE WAY YOU WORK TODAY.**

- **New REDZONE Shelving with deeper, fully-hemmed 16" shelves to fit large tool cases and boxes**
- **Easy adjustability of shelves and dividers for quick customization**
- **Optional quick-release handles**
- **Innovative Secure Storage door and drawer modules for extra theft-resistance**
- **End panel caps with easy-to-reach tie-down points**
- **Super-sturdy steel construction with legendary WEATHER GUARD® durability**

# REDZONE SHELVING

Completely redesigned FOR THE WAY YOU WORK™, WEATHER GUARD® REDZONE Shelving takes it to the max! Maximum customization and capacity, for maximum productivity. Shelves can now be adjusted quickly. Assembly and installation is faster and easier than before. Our tapered end panels and notched base maximize floor clearance for drawer units or supplies.

**WEATHER GUARD® EXCLUSIVE!**



## DEEPER 16" FULLY HEMMED SHELVES

sized for tools, equipment, and other materials



## END CAPS

for material storage and load tie-down



## OPTIONAL TOOL-LESS ADJUSTABLE SHELVES

with Quick Adjust Handle Kit



## EASY TO CUSTOMIZE

with pre-punched mounting holes for WEATHER GUARD® accessories and adjustable dividers

## 17° TAPERED END PANEL CLOSER FIT

for more working space inside the van

## FLOOR CLEARANCE

for material storage. Fits PACK RAT® Drawer Units.



## ADJUSTABLE DIVIDERS

One set of four 16" Standard Dividers or four 13" Narrow Dividers included for each shelf.

## UNMATCHED DURABILITY

achieved with heavy duty 18 gauge steel construction

## Shelf Units

MODEL	HEIGHT	WIDTH	DEPTH	SHELVES	DIVIDERS	WEIGHT	END PANEL KIT	SHELF KIT
9353-3-01	46"	36"	13"	3	8	60 lbs.	9234-3-01	9153-3-01
9354-3-01	46"	42"	13"	3	8	65 lbs.	9234-3-01	9154-3-01
9355-3-01	46"	52"	13"	3	8	69 lbs.	9234-3-01	9155-3-01
9356-3-01	46"	60"	13"	3	8	85 lbs.	9234-3-01	9156-3-01
9333-3-02 Heavy Duty	36"	36"	13"	2	8	48 lbs.	9233-3-01	9173-3-01
9334-3-02 Heavy Duty	36"	42"	13"	2	8	48 lbs.	9233-3-01	9174-3-01
9336-3-02 <sup>1</sup> Heavy Duty	36"	60"	13"	2	8	50 lbs.	9233-3-01	9176-3-01
9343-3-02 Heavy Duty	46"	36"	16"	3	12	74 lbs.	9264-3-01	9183-3-01
9344-3-02 Heavy Duty	46"	42"	16"	3	12	80 lbs.	9264-3-01	9184-3-01
9345-3-02 Heavy Duty	46"	52"	16"	3	12	85 lbs.	9264-3-01	9185-3-01
9346-3-02 <sup>1</sup> Heavy Duty	46"	60"	16"	3	12	104 lbs.	9264-3-01	9186-3-01

## Special Order Shelving Items (not pictured)

Extra deep 24" shelving constructed of 18-gauge steel and finished with durable brite white powder coat. These shelves are easy to assemble and provide the perfect foundation for a customized van or trailer. Special order only, with longer lead times.

MODEL	HEIGHT	WIDTH	DEPTH	SHELVES
8393-3-01	59½"	42¼"	24"	3
8394-3-01	59½"	51¼"	24"	3
8395-3-01	59½"	69¼"	24"	3
8118-3-01	short bin dividers for 24" d shelves.			

<sup>1</sup> Shelf Center Support included with 60" wide shelving units (see page 21)

<sup>2</sup> Reduce height 2¼" without End Caps

WEATHER GUARD® REDZONE and STARTER van shelving systems are not only easy to customize and fast to assemble, they also provide flexibility in ordering as well. Shelf sets come in popular sizes with two, three, or four shelves and make it easy to create custom configurations. Secure Storage shelf and door modules maximize efficiency and security. End panels and single shelves complete the system and are packaged separately.

**STEP 1**

## SELECT YOUR END PANELS

**Starter Set** - Durable, powder-coated steel end panels

**REDZONE** - Durable, powder-coated steel end panels that include REDZONE cargo tie-down caps

FOR	SELECT	MODEL	HEIGHT	WIDTH	WEIGHT
COMPACT VANS	REDZONE	9233-3-01	36"	13"	18 lbs.
	STARTER	9203-3-01	34"	13"	18 lbs.
FULL SIZE VANS	REDZONE	9264-3-01	46"	16"	24 lbs.
	STARTER	9204-3-01	44"	16"	24 lbs.
HIGH ROOF VANS	REDZONE	9266-3-01	62"	16"	34 lbs.
	STARTER	9206-3-01	60"	16"	34 lbs.



**STEP 2**

## SELECT YOUR SHELF SET

**Starter Set** - Durable WEATHER GUARD® powder-coated steel shelves with two divider sets.

**REDZONE** - Durable, easy to adjust, WEATHER GUARD® powder-coated steel shelves with four dividers for each shelf.

SHELF SETS					
REDZONE	STARTER	WIDTH	DEPTH	SHELVES	WEIGHT
9173-3-01	9103-3-01	36"	13"	2	72 lbs.
9174-3-01	-	42"	13"	2	58 lbs.
9175-3-01	-	52"	13"	2	68 lbs.
9176-3-01	-	60"	13"	2	80 lbs.
9183-3-01	-	36"	16"	3	36 lbs.
9184-3-01	9104-3-01	42"	16"	3	50 lbs.
9185-3-01	9105-3-01	52"	16"	3	55 lbs.
9186-3-01	9106-3-01	60"	16"	3	74 lbs.
9193-3-01	-	36"	16"	4	48 lbs.
9194-3-01	9107-3-01	42"	16"	4	68 lbs.
9195-3-01	9108-3-01	52"	16"	4	76 lbs.
9196-3-01	9109-3-01	60"	16"	4	102 lbs.

## SECURE STORAGE OPTIONS



Door Module 9040-3-01

5 Drawer Module 9045-3-01

Fully welded steel Secure Storage Modules replace two 16" deep shelves (eight mounting hole positions) for unmatched storage efficiency and security.

STEP 1 - SELECT MODULE TYPE		WIDTH	DEPTH	WEIGHT
9040-3-01	Door Module	42"	16"	47 lbs.
9045-3-01	5-Drawer Module	42"	16"	78 lbs.
STEP 2 - COMPLETE THE UNIT		WIDTH	DEPTH	WEIGHT
9992-3-01	Top Shelf	42"	13"	18 lbs.
9164-3-01	Accessory Shelf	42"	16"	20 lbs.

**STEP 3**

## GET IT INSTALLED AND GET TO WORK...OR CUSTOMIZE IT EVEN MORE

**Extra Shelves** *Can't find the combination you need? Configure your own shelf system with extra shelves*

MODEL	HEIGHT	WIDTH	DEPTH	WEIGHT
9133-3-01	2"	36"	13"	14 lbs.
9134-3-01	2"	42"	13"	18 lbs.
9135-3-01	2"	52"	13"	22 lbs.
9136-3-01	2"	60"	13"	26 lbs.
9163-3-01	2"	36"	16"	16 lbs.
9164-3-01	2"	42"	16"	20 lbs.
9165-3-01	2"	52"	16"	24 lbs.
9166-3-01	2"	60"	16"	28 lbs.

**Quick Adjust Handle Kit** *Use with any REDZONE shelf for fast, toolless adjustability*

MODEL	WEIGHT
70202	0.2 lbs.

**Divider Sets** *keep things on the shelf in place*

MODEL	HEIGHT	WIDTH	DIVIDERS	WEIGHT
9823	2"	13"	4	2 lbs.
9826	2"	16"	4	2 lbs.

**Shelf Center Support** *Increase shelf load capacity with a set of center supports. One support included with each 60" wide shelf set.*

MODEL	HEIGHT	WIDTH	DEPTH	WEIGHT
9730-3-01	36"	1.2"	1.2"	7 lbs.
9740-3-01	46"	1.2"	1.2"	9 lbs.
9760-3-01	62"	1.2"	1.2"	12 lbs.

**Nissan Mounting Kits** *required to use Nissan floor mounts*

MODEL	HEIGHT	WIDTH	DEPTH	WEIGHT
9720-3-01	3"	10"	2"	1 lb.

# SECURE STORAGE

Add extra security and theft-resistance for valuable tools and equipment with WEATHER GUARD® Secure Storage shelf units. Multiple door and drawer modules easily assemble into REDZONE Shelving. Our welded steel construction and heavy-duty locking mechanism ensures peace of mind on the job or in the parking lot.

- ! HIGH SECURITY**  
welded steel box and shelf construction
- ! UNMATCHED ORGANIZATION & EFFICIENCY**  
with no wasted space below or between drawers
- ! UNMATCHED DURABILITY**  
box construction strengthens and rigidizes shelf unit
- ! EXTRA LARGE STEEL DRAWERS**  
17"x14"x4" or 6" with ball bearing slides rated at 75 pounds per drawer
- ! FAST AND EASY ASSEMBLY**  
modules bolt to end panels. Add top shelf to complete unit.
- ! FULLY FUNCTIONAL 16" SECURE MODULE TOP**  
designed like a 16" shelf for additional storage



## Secure Storage Shelf Units (42" Wide)

MODEL	DESCRIPTION	HEIGHT	DIVIDERS	WEIGHT
<b>Full Size Vans</b>				
9380-3-02	With Door Module	46"	8	117 lbs.
9385-3-02	With 5 Drawer Module	46"	8	148 lbs.
<b>High Roof Vans</b>				
9390-3-02	With Door Module	62"	8	125 lbs.
9395-3-02	With 5 Drawer Module	62"	8	156 lbs.
<b>Storage Module Only (for 42" wide shelf units)</b>				
9040-3-01	Door Module			47 lbs.
9045-3-01	5 Drawer Module			78 lbs.

## Secure Storage Service Parts

xx- Designates key code  
Specify key code 11-20 when ordering

MODEL	DESCRIPTION	WEIGHT
70206-xx	Replacement Lock Kit	117 lbs.
70210-xx	Key kit	1 lb.
70211-xx	Replacement D Handle Kit	1 lb.



Door Module  
9040-3-01



5 Drawer  
Module  
9045-3-01



# EZ-CUBE SHELVING

Heavy-duty van storage, made easy. Our fully arc-welded WEATHER GUARD® EZ-Cube Shelving is pre-assembled and ready to install. Pre-punched shelves allow for quick installation of cabinets, bin dividers, or accessory doors. Heavy-gauge steel construction with our signature bright white powder coat ensure years of durability, and a professional appearance.

## TAPERED END PANEL DESIGN

allows a close fit to the van wall and additional cargo space in the middle of the van

## FULLY ARC WELDED

for durable construction and no assembly

## HEMMED SHELVES

provide extra strength and a lip in front of the shelf for load retention

## BOTTOM SHELF IS PRE-PUNCHED

for EZ installation of accessory cabinets on page 30



## MIDDLE TWO SHELVES ARE PRE-PUNCHED

for EZ Bin Dividers

## BOTTOM RETAINER LIP

is made of durable, heavy gauge steel

## EZ SHELF DOORS

turns bottom shelf into a cabinet



EZ Bin Dividers mount to two middle shelves

## EZ-Cube for Full-Size Vans

MODEL	SHELVES	HEIGHT	WIDTH	TOP DEPTH	BOTTOM DEPTH	WEIGHT
9400-3-01	4	43¾"	42"	11¼"	13¾"	76 lbs.
9452-3-01	4	43¾"	51"	11¼"	13¾"	90 lbs.

## Accessories for EZ-Cube Shelving

MODEL	DESCRIPTION	WEIGHT
8401-3-01	EZ Bin Dividers (8)	18 lbs.
8841	EZ Shelf Mat (trim to fit)	1 lb.
8502-3-01	EZ Shelf door, 42" wide, 10" high	17 lbs.
8503-3-01	EZ Shelf Door, 51" wide, 10" high	20 lbs.



Designed to mount to the floor or on top of the Wheel Well Base Cabinet. Dividers are welded in place.

## Welded Stack Unit

MODEL	SHELVES	HEIGHT	WIDTH	DEPTH	DIVIDERS	WEIGHT
8230-3-01	3	30"	36"	12"	6	25 lbs.



Designed to fit over the wheel well and provide a flat, sturdy foundation for Shelf Units, Parts Cabinets, or Drawer Units.

## Wheel Well Base Cabinet

MODEL	HEIGHT	WIDTH	DEPTH	WEIGHT
9444-3-01	13¾"	42¾"	15"	49 lbs.

# REDZONE

## ACCESSORIES



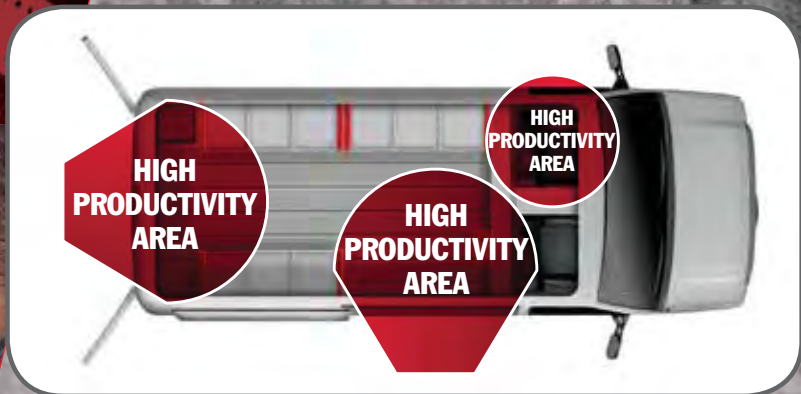

**EVERYONE WORKS HARDER IN THE REDZONE. THE DEFENSE HUNKERS DOWN. THE OFFENSE DRIVES HARDER. THE REDZONE IS WHERE WINNING TEAMS PROVE WHO THEY ARE. AT WORK, THE REDZONE IS YOUR VAN AND HOW YOU ORGANIZE IT FOR MAXIMUM PRODUCTIVITY.**

- New and re-engineered accessories that mount to end panels, bulkheads, and van doors
- Tool cabinets, parts cabinets and case, bin boxes, and locking storage cabinets
- New Cab Command Center theft-resistant, between-seat organizer for your laptop and files
- Fast installation and customizable to your job requirements
- New 3-piece, modular Grab & Go tool cart

# REDZONE ACCESSORIES

Looking for parts and supplies won't slow you down with new and re-engineered REDZONE van storage accessories. Organizers and holders keep frequently used items in easy reach for maximum productivity. Tool cabinets, parts bin boxes, and locking storage keep small components organized. Our new Cab Command Center (page 32) helps you stay in control. Door trays (page 32) make good use of empty space inside the van doors.

## CUSTOMIZED ORGANIZATION

for supplies and tools

## HEAVY DUTY 18 GAUGE STEEL CONSTRUCTION

makes for tough, long lasting accessories

## POWDER COAT FINISH

provides durability

## EASY TO INSTALL

to shelf end panels, bulkheads, and door

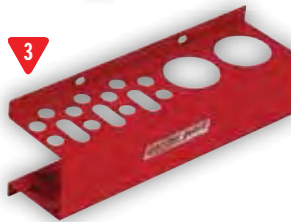

## NEW! HOOKS AND BRACKETS

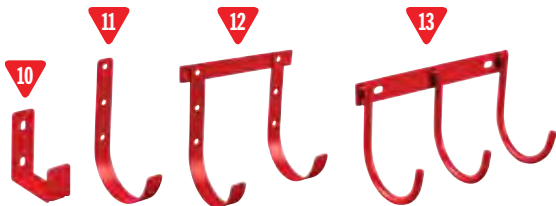

## NEW! BUCKET AND TANK HOLDERS



## REDZONE Accessories

	MODEL	DESCRIPTION	HEIGHT	WIDTH	DEPTH	WEIGHT
	1	Can Organizer	9.8	12	4	3
	2	Cleaning Station	15.5	13	7	10
	3	Tool Organizer	5.5	15	4	3
	4	Caulk Tube Tray	7.5	13.5	7.5	4.25
	5	Wire Spool Holder End Mount	26	14	6	12
NEW!	6	Large Parts Bin	11	13	7	10
NEW!	7	Medium Parts Bin	6.5	13	7	8
NEW!	8	5 Gallon Bucket Holder	6.25	11.25	11.25	8
NEW!	9	30# Refrigerant Tank Holder	10.75	9.75	9.75	9
NEW!	10	Ladder Holder	4	1.5	3.5	0.25
NEW!	11	Large Hook (5" Dia)	8	1.1.25	5	0.5
NEW!	12	2 Hook Holder (5" Dia)	8	9	5	0.5
NEW!	13	3 Hook Cord Or Tool Holder	5.25	9	4.5	0.5



# REDZONE SHELVING ACCESSORIES

WEATHER GUARD® REDZONE Shelving Accessories let you create a custom storage solution that securely organizes the items you need to locate quickly and easily.



**6 Shelf Doors with High Security D Handle Lock** mount to shelf units or, for compact van shelf units, to retainer lips. Allow six mounting spaces shelf to shelf spacing. Single point latch.

MODEL	HEIGHT	WIDTH	WEIGHT
9503-3-01	11"	36"	13 lbs.
9504-3-01	11"	42"	17 lbs.
9505-3-01	11"	52"	21 lbs.
9506-3-01	11"	60"	25 lbs.

## Light Weight Shelf Back Panels

use with shelf doors to turn a shelf into a cabinet

MODEL	HEIGHT	WIDTH	WEIGHT
9603-3-01	13½"	36"	2 lbs.
9604-3-01	13½"	42"	3 lbs.
9605-3-01	13½"	52"	4 lbs.
9606-3-01	13½"	60"	5 lbs.

## REDZONE Accessories\* End panel and shelf

MODEL	DESCRIPTION	WEIGHT
<b>11</b> 8866	Fire extinguisher	6 lbs.
<b>12</b> 8873-3-01	Extension cord brackets (3)	2 lbs.
<b>13</b> 8875	Hard hat bracket ( <i>hat not included</i> )	2 lbs.
9832	Shelf mat, narrow	1 lb.
<b>14</b> 9836	Shelf mat, wide	1 lb.
<b>15</b> 9880-3-01	Literature holder	11 lbs.
<b>16</b> 70202	Quick Release Handle Kit	0.2 lbs.



## Bin Sets sturdy plastic bins sized to fit new van shelving

MODEL	HEIGHT	WIDTH	DEPTH	BINS	WEIGHT
<b>7</b> 9854-7-01	5"	5½"	14¾"	9	1 lb.
<b>8</b> 9855-7-01	7"	8¾"	14¾"	6	1 lb.
<b>9</b> 9856-7-01	7"	16½"	14¾"	3	1 lb.

## 10 Retainer Lips keeps items in place under shelf units

MODEL	HEIGHT	WIDTH	DEPTH	WEIGHT
9703-3-01	4"	36"	2"	1 lb.
9704-3-01	4"	42"	2"	1 lb.
9705-3-01	4"	52"	2"	2 lbs.
9706-3-01	4"	60"	2"	2 lbs.

Required to use Nissan NV Floor Mounting Points





SECURE LOCK

DRAWER LATCH

### Mechanics Grade Tool Cabinets

MODEL	DRAWERS	HEIGHT	WIDTH	DEPTH	WEIGHT
1 9912-3-02	2	12"	16"	13.7"	26 lbs.
2 9914-3-02	4	12"	16"	13.7"	32 lbs.
3 9924-3-02	4	24"	16"	13.7"	48 lbs.
4 9928-3-02	8	24"	16"	13.7"	60 lbs.
5 9984-3-01	4	24"	18"	13.7"	48 lbs.
6 9988-3-01	8	24"	18"	13.7"	60 lbs.

High quality, durable Drawer Cabinets feature latches for each drawer, smooth ball-bearing rollers, and secure locks that can be keyed alike. Bin Cabinets feature hook and loop fasteners to securely hold bins in place. Innovative mounting rails speed assembly. Attach rails to cabinet and bolt to shelf. Easy to move from shelf to shelf as your needs change. **Order mounting kit separately and specify shelf size when ordering.**



VELCRO KEEPS BINS IN PLACE

### NEW! Parts Boxes & Bin Cabinets

MODEL	BINS	HEIGHT	WIDTH	DEPTH	WEIGHT
1 9906-3-02	6	4½"	32½"	11¾"	18 lbs.
2 9909-3-02	9	12"	17"	11¾"	28 lbs.
3 9918-3-02	18	12"	32½"	11¾"	54 lbs.
4 9950-3-02*	N/A	12.6"	20.3"	14.4"	4 lbs.
5 9951-9-01	N/A	3"	18½"	13"	3 lbs.

Special Order Cabinets (Call for availability. Longer lead time required)

6 8908-3	8	8½"	22 "	11¾"	24 lbs.
7 8931-3		15¾"	21¾"	12¾"	28 lbs.

\*Parts cases not included

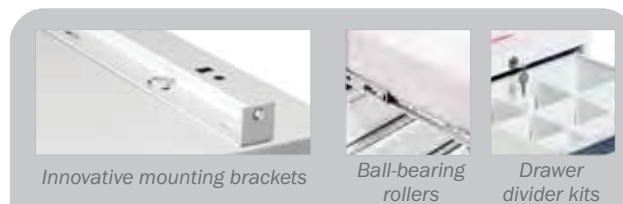

Innovative mounting brackets

Ball-bearing rollers

Drawer divider kits

### Mounting Kits & Divider Kits

MODEL	DESCRIPTION	WEIGHT
9993-3-01	Mounting bracket kit for 13" shelves	1 lb.
9996-3-01	Mounting bracket kit for 16" shelves	1 lb.
7220	Mounting bracket kit for 14" knockdown shelves	1 lb.
9822-3-01	Divider and liner kit for narrow drawers	2 lbs.
9824-3-01	Divider and liner kit for deep drawers	2 lbs.

Drawer and Bin Cabinets work with space saving 13" deep shelving or Heavy Duty 16" shelving. **Specify shelf size when ordering.**



### Locking Storage & CATV Cabinets

	MODEL	SHELVES	HEIGHT	WIDTH	DEPTH	WEIGHT
1	9020-3-01	N/A	22"	18"	16"	25 lbs.
2	9021-3-01	2*	22"	18"	16"	35 lbs.
3	9029-3-01	N/A	22"	18"	16"	25 lbs.
4	8313-3	N/A	20"	20"	17½"	25 lbs.
5	8316-3	4*	21"	20"	14"	43 lbs.

\*Removable Shelves

Great for securing electronics or expensive equipment. Our new locking storage cabinets feature secure locking D-Handles and tool-less reversible doors.

9029-3-01 is an open base unit with a handy storage bin. CATV units (8313-3-01 and 8316-3-01) feature padded interiors and traditional handle doors.



### Grab & Go Tool Cart

	MODEL	HEIGHT	WIDTH	DEPTH	BOXES	WEIGHT
	9953-7-01	28½"	20"	12"	3	24 lbs.

Our new, modular 3-piece rolling tool chest puts those tools and parts used on every job at your fingertips. Heavy-duty construction keeps your productivity rolling for years to come.

- Modular, 3-piece rolling tool chest
- Removable tool box with steel tray
- Sliding drawer unit
- Tilt-out storage bin
- Telescoping handle



### Floor Mounted Accessories

	MODEL	DESCRIPTION	HEIGHT	WIDTH	DEPTH	WEIGHT
1	9861-3-01	Cable spool holder	42½"	19¾"	16¼"	37 lbs.
2	9862-3-01	3 - 50 lb. tank holder	45½"	15½"	8"	31 lbs.
3	9863-3-01	2 - 30 lb., 1 - 50 lb. tank holder	40"	15½"	8"	27 lbs.
4	9864-3-01	4 - 30 lb. tank holder	48½"	13"	8"	31 lbs.
5	9860-3-01	Catalog file unit	36"	6"	12"	16 lbs.

You're a professional, a specialist. You need specific equipment to keep at the top of your game. WEATHER GUARD® Van Solutions has what you need. Tank and cable racks, and work tops. Whatever you need. For The Way You Work™.



### Specialty Equipment

	MODEL	DESCRIPTION	HEIGHT	WIDTH	DEPTH	WEIGHT
1	9444-3-01	Wheel Well Cabinet	13¾"	42¾"	15"	9 lbs.
2	9912-3-01	2 Drawer Cabinet	12"	16"	13.7"	26 lbs.
3	9914-3-01	2 Drawer Cabinet	12"	16"	13.7"	32 lbs.
4	8867-3-01	Steel work top	1½"	42"	18"	6 lbs.

# CAB COMMAND CENTER ⚠

Rethought and repurposed. Not a file box, but a between-seat Cab Command Center! Plenty of room for your laptop and hanging files. Handy clip board on lid and extra storage for personal items. Power Pass® electrical pass-thru grommet lets you keep everything charged while you're on the road. Our D-Handle lock keeps everything safe when you're on the job. Easy to release interior latch lets you take it when you need it.

## SECURE D HANDLE LOCKS

single point latching for theft-resistance

## HIDDEN LATCH TO BASE ⚠

means only you can remove it from your vehicle

## SIMPLIFIED INSTALLATION

gets you back on the job quickly

## RAISED MOUNTING BASE FOR 6" FLOOR CLEARANCE

with tamper-resistant Torx® head mounting bolts

## POWER PASS® ELECTRICAL PASS-THRU GROMMET ⚠

allows you to charge items within the box



### Cab Command Center

MODEL	HEIGHT	WIDTH	DEPTH	WEIGHT
9012-3-01	12"	13"	20"	30 lbs.

**WEATHER GUARD® EXCLUSIVE!** ⚠



### Door Trays and Literature Holders

	MODEL	HEIGHT	WIDTH	WEIGHT
1	9871-3-01	21¾"	20¾"	19 lbs.
2	9872-3-01	21¾"	20¾"	18 lbs.
3	9873-3-01	21¾"	20¾"	19 lbs.

  

	MODEL	BINS	HEIGHT	WIDTH	DEPTH	WEIGHT
4	9880-3-01	6	15"	13"	4¾"	11 lbs.

These door organizers keep tools and supplies close by. No digging around inside the van for those items used on every job. Durable steel trays and lids keep everything in place while driving. Adjustable dividers let you customize. For The Way You Work™.

You not only build or repair, but educate and inform customers. Catalog and literature holders keep information at hand, for your customers or crews.



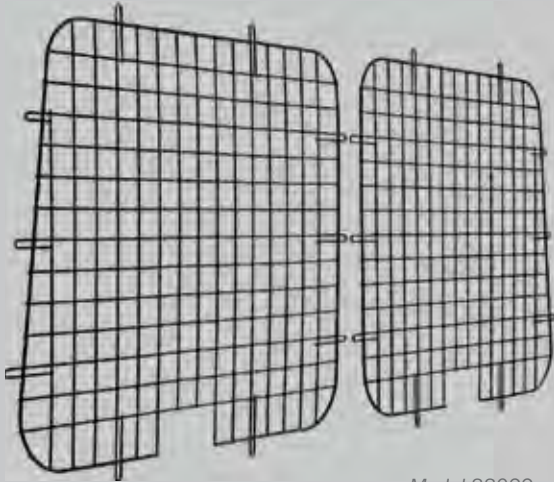

Model 88022

### Window Screens

MODEL	VAN TYPE	QUANT.	DESCRIPTION	WEIGHT
88021	'92 & Newer Full-size Ford	2	Side Door - Hinged	8 lbs.
88022	'92 & Newer Full-size Ford	2	Rear Door - Hinged	8 lbs.
88023	'92 & Newer Full-size Ford	1	Side Door - Sliding	8 lbs.
88026	'96 & Newer Full-size GM	2	Side Door - Sliding	8 lbs.
88027	'96 & Newer Full-size GM	2	Side Door - Hinged	7 lbs.
88028	'96 & Newer Full-size GM	2	Rear Door - Hinged	8 lbs.
88040	'07 & Newer Dodge Sprinter	1	Side Door	7 lbs.
88041	'07 & Newer Dodge Sprinter	2	Rear Door	9 lbs.
88042	'08 & Newer Dodge RAM CV	2	Side Door - Sliding	6 lbs.
88043	'08 & Newer Dodge RAM CV	2	Rear Side Windows	7 lbs.
88044	'09 Dodge RAM CV	1	Rear Door - Hatch	6 lbs.
88045	'10 Ford Transit Connect	2	Rear Door	7 lbs.
88046	'10 Ford Transit Connect	2	Side Door	9 lbs.
88047	'10 Ford Transit Connect	2	Side Rear Window	7 lbs.



High-security box for the inside of a van that features ¼" plate steel around the lid opening and the WATCHMAN® IV Lock System.

### Strong Box

MODEL	HEIGHT	WIDTH	DEPTH	WEIGHT
9036-3	16"	36¾"	19¾"	93 lbs.



Model 89015

### Van Floor Mats

MODEL	VAN TYPE	WEIGHT
89011	70" x 124" rectangular, must be cut to fit any style vans	55 lbs.
89015	'96 & newer GM 135" wheel base	55 lbs.
89017	'92 & newer Ford standard wheel base	60 lbs.
88530-5-01	Designed exclusively for the 2005 & newer Dodge Grand Caravan CV	70 lbs.

Designed to cover seating wells in the van floor. Required when installing bulkhead units and other equipment.

# *SPECIALTY STORAGE*





**WHATEVER YOUR SPECIALTY IS, OURS IS KEEPING THE TOOLS OF YOUR TRADE SECURE AND EASY TO ACCESS. WE CONSIDERED THE BIG THINGS AND THE SMALL DETAILS TO GIVE YOU MORE ORGANIZATION.**

- **New Tool Drawer with Power Pass® Electrical Pass-Thru Grommet keeps tools ready to roll**
- **Heavy-duty PACK RAT® Drawer Units for easy access and organization**
- **ITEMIZER® Drawer Units lightweight storage are stackable with adjustable dividers**
- **BED RAT® Sliding Platforms for both side and rear door openings**

# PACK RAT® DRAWER UNITS

Have your equipment waiting for you as soon as you open the door. These heavy-duty pull-out drawer units can be mounted inside the side or rear door openings. They offer easy access to hundreds of pounds of tools and supplies, while leaving floor space open for hauling materials or moving in and out of the vehicle.



## INTRODUCING OUR NEW PACK RAT® DRAWER UNIT FOR POWER TOOLS



### ONE-TOUCH RED PUSHBUTTON LATCH ASSEMBLY

*allows for one hand operation*

### HEAVY GAUGE ALUMINUM

*is strong, but light, with a  
225 pound load rating*

### SMOOTH ROLLING DRAWER

*for easy access and organization*

### ANTI-SKID STRIPS

*provide traction for  
wet and muddy boots*

### EASY MAINTENANCE

*drawers are completely  
removable to clean,  
lubricate, and service*



### POWER PASS® ELECTRICAL PASS-THRU GROMMET

*for tool charging*



**WEATHER GUARD® EXCLUSIVE!**



### 14-GAUGE STEEL

*on top and sides allows for a 750 lb. load  
rating when evenly distributed on top of unit*

### 12-GAUGE STEEL SKIDS

*and full width ribs underneath and inside  
the unit add extra strength*

### SMOOTH ROLLING DRAWER

*provides trouble free operation and  
handles up to 425 lbs. of equipment*





**Drawer  
Compartment**  
14½" H x 11¾" W  
x 39" L



**Smaller  
Compartment**  
8½" H x 9¾" W  
x 45" L

**Larger  
Compartment**  
8½" H x 19½" W x  
45" L

### NEW Tool Drawer

MODEL	HEIGHT	WIDTH	DEPTH	COMPARTMENTS	WEIGHT
310-3-01	17¾"	12¼"	42"	1	56 lbs.

### Extra Wide Compartment 48" Long Drawer Unit

MODEL	HEIGHT	WIDTH	COMPARTMENTS	DIVIDERS	WEIGHT
304-3	9"	30"	2	6	220 lbs.
334-3	12"	30"	2	6	245 lbs.



Each Drawer  
Compartment  
Measures 5" H  
x 9¾" W x 21" L



Each Drawer  
Compartment  
Measures 8½" H x  
9¾" W x 21" L

### 9" High, 24" Long Drawer Unit

MODEL	WIDTH	COMPARTMENTS	DIVIDERS	WEIGHT
312-3	30"	3	12	151 lbs.

### 12½" High, 24" Long Drawer Units

MODEL	WIDTH	COMPARTMENTS	DIVIDERS	WEIGHT
301-3	30"	3	12	169 lbs.
303-3	39¾"	4	12	217 lbs.



Each Drawer  
Compartment  
Measures 5" H  
x 9¾" W x 45" L



Each Drawer  
Compartment  
Measures 8½" H x  
9¾" W x 45" L

### 9" High, 48" Long Drawer Units

MODEL	WIDTH	COMPARTMENTS	DIVIDERS	WEIGHT
305-3	10¼"	1	6	106 lbs.
306-3	20"	2	12	179 lbs.
307-3	30"	3	18	247 lbs.
308-3 (white)	39¾"	4	24	322 lbs.
308-5 (black)	39¾"	4	24	322 lbs.

### 12½" High, 48" Long Drawer Units

MODEL	WIDTH	COMPARTMENTS	DIVIDERS	WEIGHT
335-3	10¼"	1	6	130 lbs.
336-3	20"	2	12	210 lbs.
337-3	30"	3	18	294 lbs.
338-3 (white)	39¾"	4	24	383 lbs.
338-5 (black)	39¾"	4	24	383 lbs.

# ITEMIZER® DRAWER UNITS

This exclusive, lightweight aluminum storage solution conveniently increases your storage space by placing small equipment at your fingertips without the need to crawl inside the van. Drawer dividers provide an extensive array of organizing options.

## LIGHTWEIGHT ALUMINUM DRAWERS

carry up to 75 lbs. of equipment each

## UNITS CAN BE STACKED

as needed for additional storage

## ROLLER MOUNTED DRAWERS

glide open to full extension

## ADJUSTABLE DRAWER DIVIDERS

offer greater flexibility



Model 318-3

## ANTI-SKID STRIPS

provides traction for wet and muddy boots

## LOCK MOUNT

is provided for installation of optional camlock

Model 314-3

1 Drawer

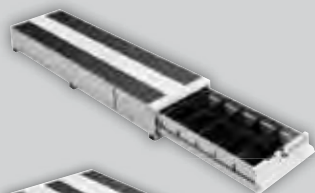

Model 316-3

2 Drawer Lateral

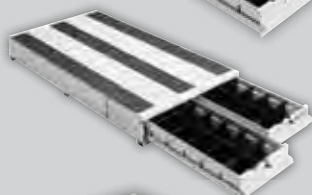

Model 317-3

3 Drawer Lateral

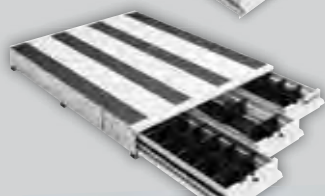

Model 318-3

4 Drawer Lateral

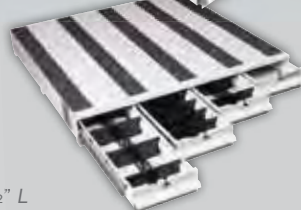

Each Drawer  
Compartment Measures  
4¼" H x 10½" W x 46½" L

Model 326-3

2 Drawer Stacked

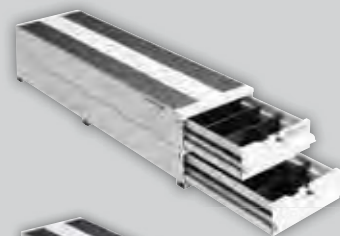

Model 327-3

3 Drawer Stacked

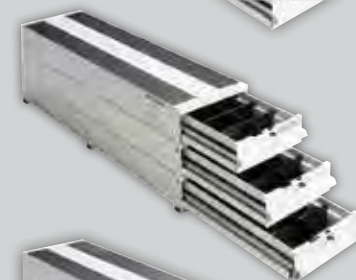

Model 328-3

4 Drawer Stacked

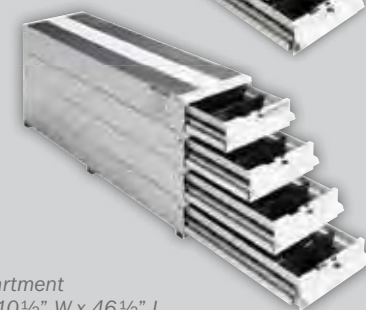

Each Drawer Compartment  
Measures 4¼" H x 10½" W x 46½" L

## Lateral Drawer Units

MODEL	DRAWERS	HEIGHT	WIDTH	DEPTH	WEIGHT
314-3	1	6¾"	12¼"	49"	26 lbs.
316-3	2 Lateral	6¾"	24"	49"	55 lbs.
317-3	3 Lateral	6¾"	36"	49"	85 lbs.
318-3	4 Lateral	6¾"	48"	49"	110 lbs.

## Stacked Drawer Units

MODEL	DRAWERS	HEIGHT	WIDTH	DEPTH	WEIGHT
326-3	2 Stacked	12¼"	12¼"	49"	48 lbs.
327-3	3 Stacked	17¾"	12¼"	49"	71 lbs.
328-3	4 Stacked	23½"	12¼"	49"	92 lbs.

# BED RAT® SLIDING PLATFORM

Extend your van's workspace and bring heavy loads to you, instead of bending in to get them, with this sliding platform. Sized to fit your work needs, BED RAT® Sliding Platforms are available for both side and rear door openings.

## 70% EXTENSION

for easy access of stored materials and tools

## 750 LB. TOTAL CAPACITY

when weight is evenly distributed on the platform

## 10½" HIGH SIDE PANELS

are made from steel and help keep materials on the deck



Decking material is not included, ¾" plywood is recommended

## FOR FULL-SIZE VAN SIDE DOOR

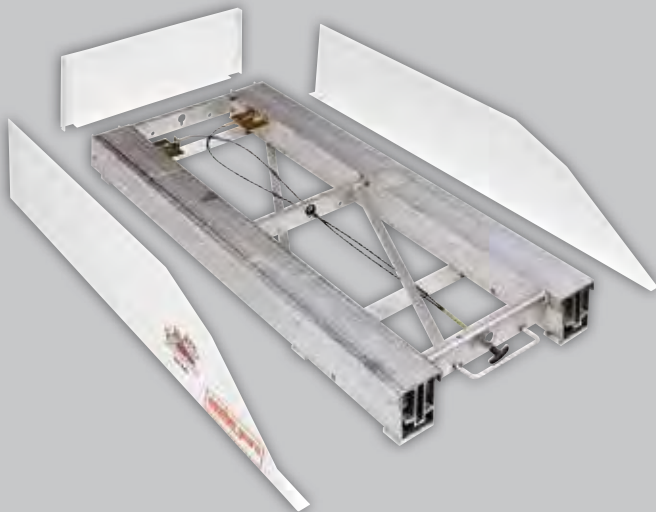

### Model 3100

Perfect for curb side loading and unloading from the side door of Full-size vans.

## FOR FULL-SIZE VAN & MINIVAN REAR DOOR

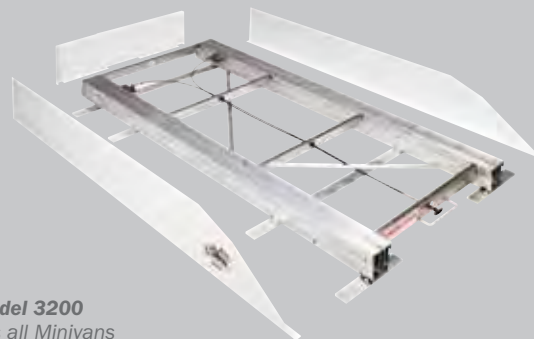

### Model 3200

Fits all Minivans and Full-size vans.

## FOR LONG WHEEL BASE FULL-SIZE VAN REAR DOOR

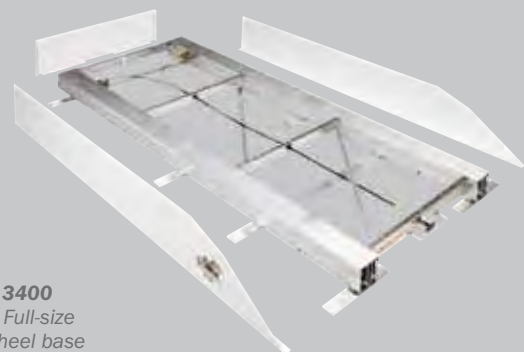

### Model 3400

Fits all Full-size long wheel base and extended vans

## BED RAT® Sliding Platforms

MODEL	HEIGHT	WIDTH	DEPTH	WEIGHT
3100	4¾"	22"-44¾"	54"	97 lbs.
3200	4¾"	44¾"	68"	123 lbs.
3400	4¾"	44¾"	90"	155 lbs.

The BED RAT® can fit a 22" - 44 ¾" deck

# ROOF RACKS







**THERE'S ANOTHER IMPORTANT WORK ZONE ON YOUR VAN. JUST LOOK UP. YEP, THERE'S A LOT OF VALUABLE SPACE ON THE ROOF JUST BEGGING TO BE UTILIZED. WEATHER GUARD® ROOF RACKS KEEP YOU IN THE REDZONE BY STORING OVERSIZED ITEMS LIKE CONDUIT, PIPE, AND LADDERS SECURELY.**

- Roof racks for every van type, from compacts to cubes, high-roofs and more
- EZ-GLIDE® System for quick and easy ladder drop-down
- QUICK CLAMP aluminum racks for full-size or compact vans
- All-Purpose Racks offer a number of mounting and accessory options



# EZ-GLIDE<sup>®</sup> SYSTEM

The quickest, easiest, and safest drop-down ladder rack system available. With just a twist of a lever, EZ-GLIDE<sup>®</sup> System gently delivers your ladder to the right spot for back-saving loading and unloading. When the work is done, another twist is all it takes to have the ladder packed away and ready to roll.

**! INCREASED PRODUCTIVITY**  
Get ladders off your van on the job faster and reduce worker fatigue and injuries

**STOW AND SECURE**  
interlocking ladder supports ensure ladders stay in place when stowed. Ladders can be padlocked for added security

**MULTI-USE DESIGN**  
will accommodate extension ladders and certain step ladders

**NEW HIGH ROOF VANS**  
perfect for raising ladders to the roof of new tall vans

**LONG-LASTING DURABILITY**  
with lightweight aluminum frame keeps rust at bay for a long-lasting, professional appearance.  
Rust-proof stainless steel fasteners and non-metallic bushings eliminate bi-metal corrosion



**STEP LADDERS** Most models will accept a 6' or 8' step ladder with a bottom width not exceeding 27". Repositioning of the ladder stops is required if the bottom width of the ladder is between 25" and 27". An accessory cross member may be required depending on the distance between the front and rear cross members

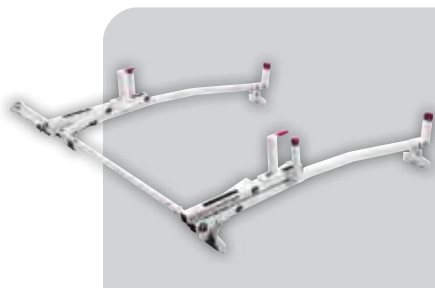

The essential EZ-GLIDE<sup>®</sup> System rack comes with a drop-down system on the passenger side and a standard ladder rack on the driver's side. Maximum ladder weight of 75 lbs. per drop-down assembly.

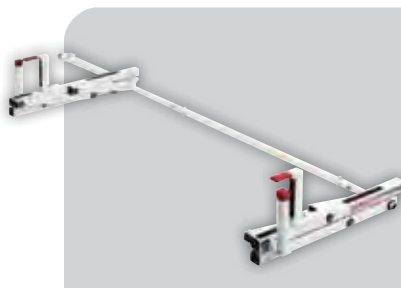

The driver's side drop-down kit is universal and fits the EZ-GLIDE<sup>®</sup> System racks by unbolting the driver side end posts and bolting the kit in place. Maximum ladder weight of 75 lbs. per drop-down assembly.

## EZ-GLIDE<sup>®</sup> System Racks

MODEL	DETAILS	WEIGHT
251-3-02	For Ford Vans. Mounts to rain gutters	62 lbs.
252-3-02	For GM Vans. Mounts to rain gutters	62 lbs.
253	For Compact Size Vans. Bolts through the roof	67 lbs.

## Driver's Side Drop-Down Kit

MODEL	DETAILS	WEIGHT
255	For Full-Size Vans. Fits models 251-3-02, 252-3-02, 253	45 lbs.
286-3-01	Fits model 280-3-01, 262-3-01	63 lbs.
287-3-01	Fits model 285-3-01, 261-3-01	54 lbs.



These unique racks utilize the same professional-grade EZ-GLIDE® System as our Full-size van and Minivan models, with added features designed specifically for standard and high roof vans. An added slide down system lowers the ladder an additional 2 ft. after the drop-down rotation.

### High Roof Van EZ-GLIDE® System Racks

MODEL	DETAILS	WEIGHT
280-3-01	For High Roof vans, passenger side. Includes rear slide down system	80 lbs.
285-3-01	For Standard Roof vans, passenger side. Does not include rear slide down system	70 lbs.



Engineered for 8' and 10' high Cube vans with flat roofs. These racks feature the same drop-down system that lowers the ladder to an easy to reach position for easy loading and unloading. An added slide down system on the 10' High Cube Racks lowers the ladder an additional 2 ft. after the drop-down rotation.

### 8' and 10' High Cube EZ-GLIDE® System Racks

MODEL	DETAILS	WEIGHT
281	For 8' high Cube vans passenger side	66 lbs.
283	For 8' high Cube vans driver side	66 lbs.
282	For 10' high Cube vans passenger side. Includes rear slide down system	75 lbs.
284	For 10' high Cube vans driver side. Includes rear slide down system	75 lbs.

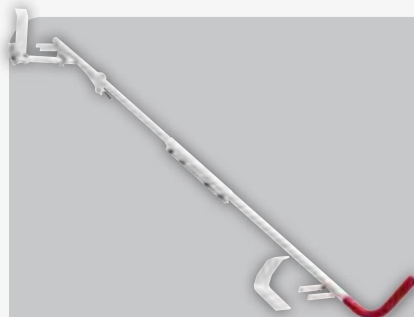

The driver's side clamp kit is universal and fits the EZ-GLIDE® System racks by unbolting the driver side end posts and bolting the kit in place.

### Driver's Side Clamp Kit

MODEL	DETAILS	WEIGHT
254	Fits models 251-3-02, 252-3-02, 253	14 lbs.

### Mounting Kits

MODEL	DETAILS	WEIGHT
<b>No kit needed for Sprinter vans with factory installed roof rails</b>		
2505	KUV Mounting Brackets (use with model 281-284 ladder racks)	9 lbs.
2506	Nissan NV High Roof Mounting Kit	15 lbs.
2507	Nissan NV Standard Roof Mounting Kit	15 lbs.
2508F	PROMASTER Mounting Kit - includes two mounting feet (use on street side)	
2508T	PROMASTER Mounting Kit with Connecting Tube (use two 2508T for drop down side)	



### Accessories

MODEL	DETAILS	WEIGHT
1 2501	Warning Light Holder	3 lbs.
2 2502	Mirror Holder (not for use with 255 Driver's Side Drop-Down kit)	3 lbs.
3 2503	Velcro Straps	1 lb.
4 2504	Mirror	2 lbs.



For use when your van length or load requirements require a cross member. Each of our cross members are vehicle specific and attach easily to any of our Full-size van or Minivan racks.

### Accessory Cross Members

MODEL	DETAILS	WEIGHT
2511	Fits model 251-3-02	14 lbs.
2521	Fits model 252-3-02	14 lbs.
2531	Fits model 253	13 lbs.

# QUICK CLAMP ALUMINUM RACKS

## FOR FULL-SIZE VANS

Our Quick Clamp Racks are engineered to make loading and unloading your ladder an easy, one-person operation. Lean the front of the ladder against the front hook and swing the back up onto the rack. Close the gas spring assisted Quick Clamp and you're ready to roll.



### WEATHER GUARD® VAN SOLUTIONS TRADEMARKED RED TIPS

show the world that you work with the highest quality equipment available

### LONG LASTING DESIGN

utilizing 3/16" extruded aluminum rails, stainless steel gutter clamps and hardware. Gas springs with internal brass bushings prevent strip-out

### LADDER HOOKS

on the front end of the side rails have been extended and angled outward for easier loading of ladders in tight places



Model 234-3-01

### ANTI-WEAR PROTECTION

on clamps helps protect ladders during transport

### ADJUSTABLE SWAY BRACES

for easy ladder change out

WEATHER GUARD® EXCLUSIVE!



### Quick Clamp Racks for Full-Size Vans



MODEL	DETAILS	WEIGHT
234-3-01	Dual clamp on the street and curb side	76 lbs.
236-3-01	Single clamp on the curb side only	73 lbs.



Works with model 234-3 and 236-3 Quick Clamp Racks to accommodate short ladders and provide additional support.

### Accessory Cross Member for Full-Size Vans

MODEL	DETAILS	WEIGHT
233-3-01	Fits models 234-3-01, 236-3-01	21 lbs.

### Gutter Clamps



Mounting leg attaches to the van with a stainless steel gutter clamp painted brite white.

### Quick Clamp



Patented Quick Clamp Rack clamping mechanism can be locked with a padlock for security.

### Additional Support



Center mounting leg provides additional support and stability.



# FOR COMPACT VANS

Offering the same easy loading and unloading as our full-size rack, our Quick Clamp Rack for Compact Vans offers easy access in tight places and special elastomer mounting pads that provide a weather tight seal around the mounting bases.

### LONG LASTING DESIGN

utilizing 3/16" extruded aluminum rails, stainless steel gutter clamps and hardware

### LADDER HOOKS

on the front end of the side rail have been extended and angled outward for easier loading of ladders in tight places

### ELASTOMER MOUNTING PADS

are included to provide a weather tight seal around mounting bolts

### ANTI-WEAR PROTECTION

on clamps helps protect ladders during transport

### ADJUSTABLE SWAY BRACES

for easy ladder change out



Model 224-3-01

## Quick Clamp Racks Compact Vans



MODEL	DETAILS	WEIGHT
223-3-01	Single clamp on the curb side only	41 lbs.
224-3-01	Dual clamp on the street and curb side	46 lbs.



Works with models 223-3 and 224-3 Quick Clamp Racks to accommodate short ladders and provide additional support.

## Accessory Cross Member for Compact Vans

MODEL	DETAILS	WEIGHT
225-3	Fits models 223-3-01, 224-3-01	16 lbs.

## Mounting Bases



Designed to rotate and to easily adjust to the contours of the van roof.

## Quick Clamp



Patented Quick Clamp Rack clamping mechanism can be locked with a padlock for security.

## Mounting Kits

MODEL	DETAILS	WEIGHT
226-3-01	Mounting Bracket Kit for 2010-2013 Ford Transit Connect	6 lbs.

# ALL-PURPOSE RACKS

Versatile and rugged, our All-Purpose Racks create a space for all the long equipment you need to carry. Available in aluminum or steel, WEATHER GUARD® Roof Racks offer a number of different mounting and accessory options.

## ANTI-WEAR PROTECTION

on cross members protect ladders and building materials during transport

## STAINLESS STEEL HARDWARE

stands tough against time and weather

## WEATHER GUARD® VAN SOLUTIONS TRADEMARKED RED TIPS

tell everyone that you work with the best

All-Purpose Racks install using 2506 and 2507 mounting kits (pg. 43)

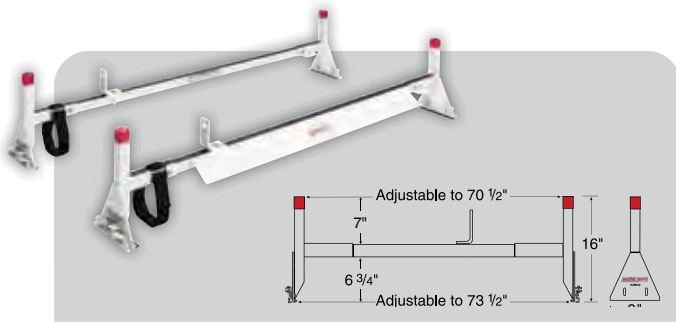

### Powder Coated Aluminum Rack for Full-Size Vans

MODEL	DETAILS	WEIGHT
209-3	2 Cross Member Rack	31 lbs.
229-3	3 Cross Member Rack	43 lbs.
2097-3	Accessory Cross Member	20 lbs.

This All-Purpose Rack is designed to clamp to roof gutters. It features extruded aluminum cross members with a double tube design for maximum carrying capacity.

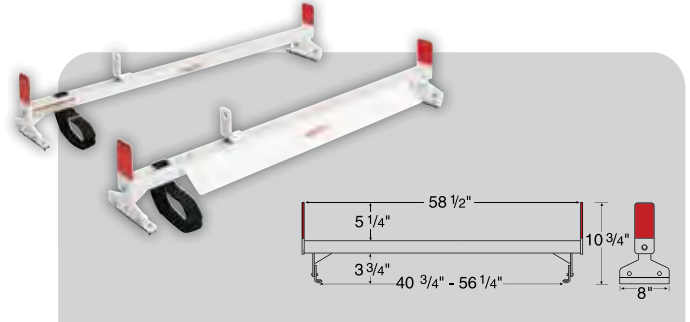

### Powder Coated Aluminum Rack for Compact Size Vans

MODEL	DETAILS	WEIGHT
218-3	2 Cross Member Rack	25 lbs.
222-3	Accessory Cross Member	13 lbs.
226-3-01	Fits model 224-3-01. Optional Mounting Bracket Kit for Ford Transit Connect	6 lbs.

This All-Purpose Rack has a specially designed mounting leg that fully adjusts to the contour of the van roof, for secure through-the-roof mounting.

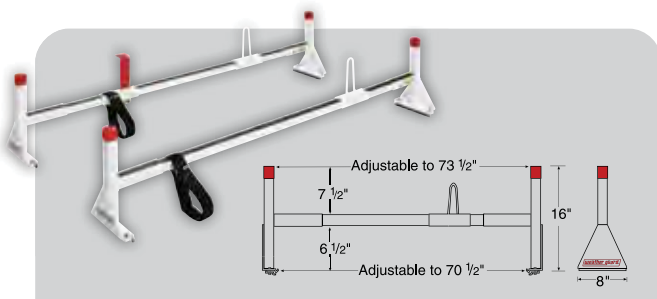

### Powder Coated Heavy Duty Steel Rack for Full-Size Vans

MODEL (white)	DETAILS	WEIGHT
205-3	2 Cross Member Rack	42 lbs.
216-3	3 Cross Member Rack	62 lbs.
2056-3	Accessory Cross Member	23 lbs.

This All-Purpose Rack features cross members made of 14-gauge steel tubing. Mounting base is extra-wide 12-gauge steel for superior attachment strength to the gutter.

Also available in black: models 205-5, 216-5, 2056-5.

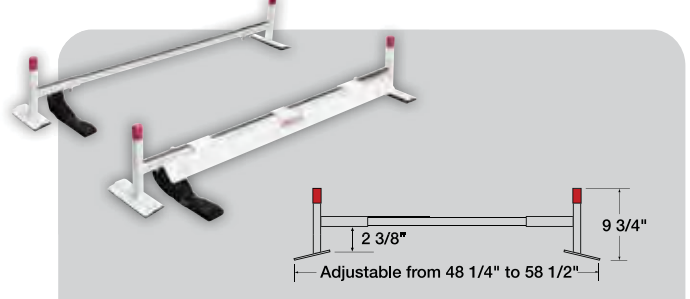

### Powder Coated Steel Rack for Compact Size Vans

MODEL	DETAILS	WEIGHT
220-3	2 Cross Member Rack	25 lbs.
221-3	Accessory Cross Member	11 lbs.

This All-Purpose Rack features cross members made of 14-gauge steel tubing and a specially designed mounting base for secure through-the-roof mounting.

# SAFARI RACK FOR FULL-SIZE VANS

Excellent for hauling all types of materials, the Safari Rack easily accommodates 4-foot wide loads and distributes the weight evenly over eight cross members to protect the roof of the van. The OVAL RAIL DESIGN side rail is unique to WEATHER GUARD® Van Solutions.

## FRONT & REAR CROSS MEMBERS

extend over the ends of the van for protection when loading ladders and other long materials

## ANTI-WEAR PROTECTION

on cross members helps protect ladders and building materials during transport

## CROSS MEMBERS

are constructed of 13-gauge, 1¼" x 1¼" square steel tubing and spread the load evenly to protect long, fragile materials

## STAINLESS STEEL MOUNTING BRACKETS

are extra wide for superior attachment strength to the gutter



## AIR FOIL

eliminates wind noise and mounts to the front of the cross member

## VELCRO STRAPS

assist in securing your ladder for transport

## CENTER LEG



## TIE DOWNS



MODEL	HEIGHT	WIDTH	WEIGHT
210-3	150¾"	64"	205 lbs.

For Full-size vans only. Length from front to rear cross member is 140"

# SLIDING LADDER RACK

Our Sliding Ladder Rack provides quick and easy ladder storage inside your van, enclosed trailer, or cube van. Rugged and durable, this rack fits 8-foot step, extension, or multi-position ladders and can be mounted to the roof or side panel.

## UNIVERSAL MOUNTING BRACKET

adjusts to different vehicles

## SAFETY CABLE

secures ladder in place

## 3-PIECE RAIL ASSEMBLY

accepts up to an 8' ladder

## ROOF MOUNTING BRACKET

is provided for horizontal installation



## MOUNTING BRACKETS



## ADJUSTABLE CRADLE

accommodates different types of ladders

## TENSION CORD GUIDE

prevents cords from tangling

MODEL	WEIGHT
250	27 lbs.

## SIDE MOUNT



# CONDUIT CARRIERS

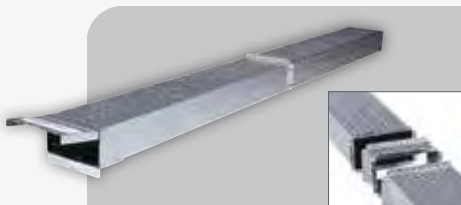

Keep your conduit safe, secure, and clean with our lightweight and durable Conduit Carrier.



PVC not included. Separately purchase a section of standard 6" PVC (9ASTM D2665) plastic drain pipe. Coordinate the length of the PVC with the length of conduit you'll be carrying.

## Aluminum Conduit Carrier

MODEL	DETAILS	LENGTH	WIDTH	HEIGHT	WEIGHT
237	Conduit Carrier	121½"	11"	6"	40 lbs.
238	Extension	6"	11"	6"	4 lbs.

## Make-Your-Own Conduit Carrier

MODEL	WEIGHT
239	4 lbs.

(Not for use with 2511 or 2521 EZ-Glide® Cross Members.)

# VEHICLE FITTING GUIDE

## Full-Size Van GM

INTERIOR DIMENSIONS

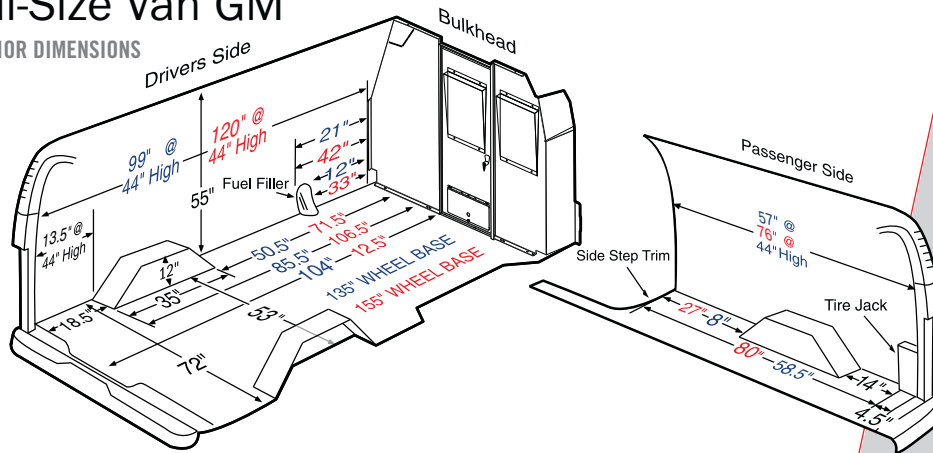

Note: Verify the location of the gas tank before installing any equipment.

The dimensions shown in this guide refer to model year 2014 Full-size Chevy Express/GMC Savana. Dimensions printed in blue refer to the 135" wheel base vans, dimensions printed in red refer to the 155" wheel base vans. Dimensions printed in black are common to both. You should always measure your van carefully to make sure the equipment you choose will fit properly.

## Full-Size Van Ford

INTERIOR DIMENSIONS

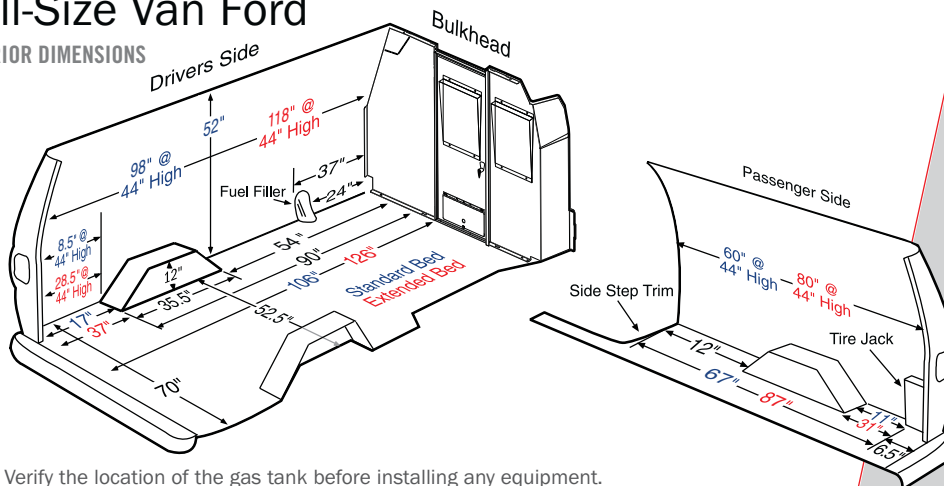

Note: Verify the location of the gas tank before installing any equipment.

The dimensions shown in this guide refer to model year 2014 Full-size Ford Econoline vans. Dimensions printed in blue refer to standard wheel base vans, dimensions printed in red refer to extended wheel base vans. Dimensions printed in black are common to both. You should always measure your van carefully to make sure the equipment you choose will fit properly.

## Nissan NV (Standard & Extended Roof)

INTERIOR DIMENSIONS

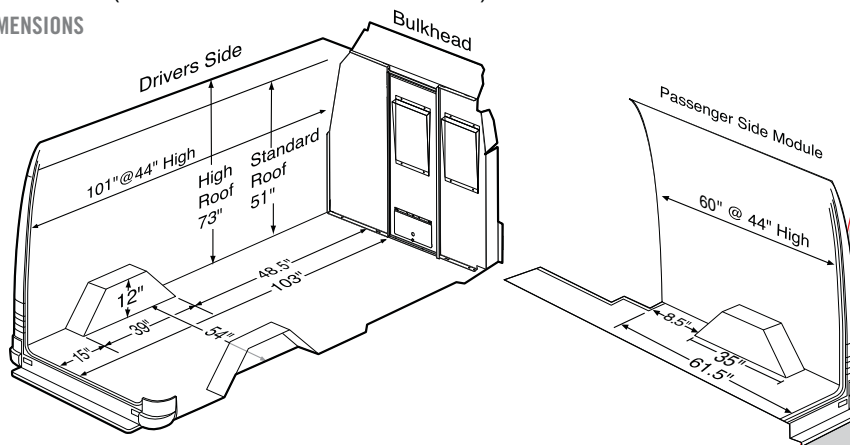

Note: Verify the location of the gas tank before installing any equipment.

The dimensions shown in this guide refer to model year 2014 Nissan NV Van. You should always measure your van carefully to make sure the equipment you choose will fit properly.



## Sprinter Van

### INTERIOR DIMENSIONS

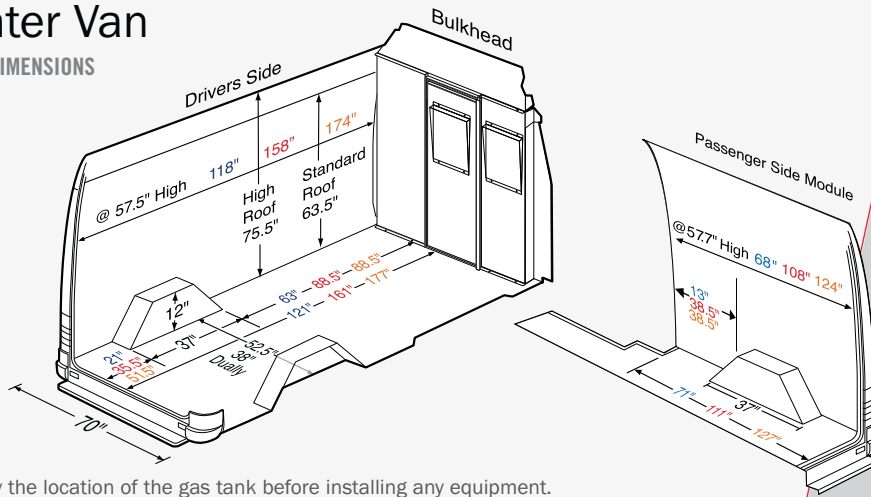

Note: Verify the location of the gas tank before installing any equipment.

The dimensions shown in this guide refer to model year 2007-2014 Sprinter vans. Dimensions printed in blue refer to 144" wheel base vans, dimensions printed in red refer to the 170" wheel base vans and dimensions printed in orange refer to the 170" extended wheel base vans. Dimensions printed in black are common to all. You should always measure your van carefully to make sure the equipment you choose will fit properly.

## Dodge Ram C/V

### INTERIOR DIMENSIONS

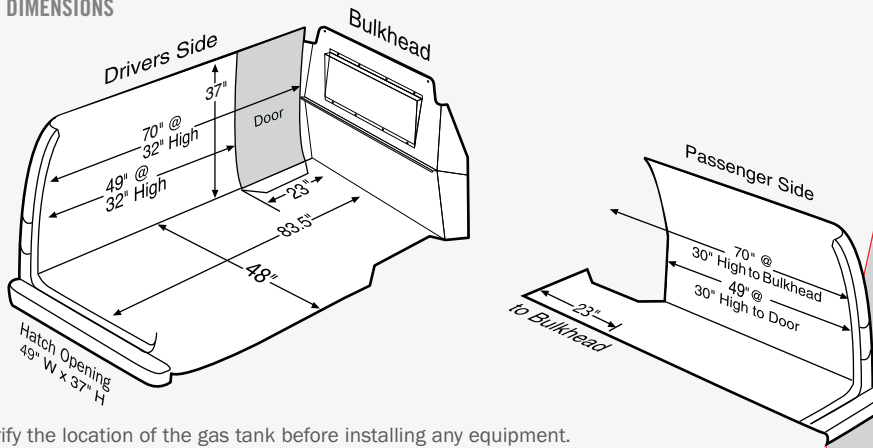

Note: Verify the location of the gas tank before installing any equipment.

The dimensions shown in this guide refer to model year 2014 RAM C/V. You should always measure your van carefully to make sure the equipment you choose will fit properly.

## Ford Transit Connect

### INTERIOR DIMENSIONS

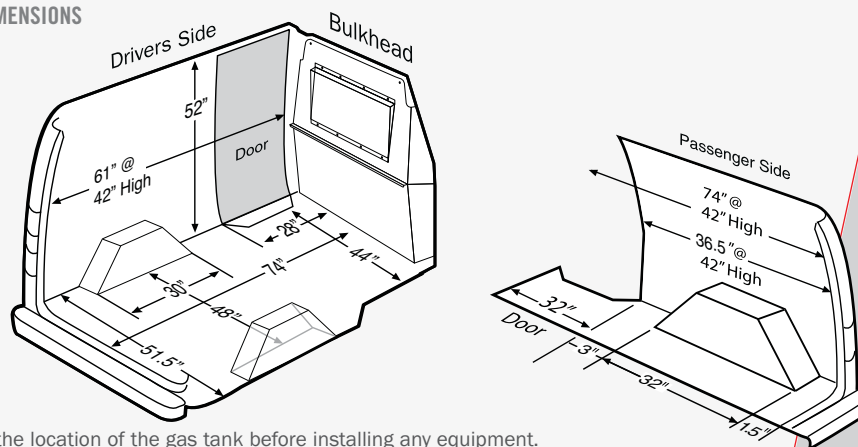

Note: Verify the location of the gas tank before installing any equipment.

The dimensions shown in this guide refer to model year 2013 Ford Transit Connect. You should always measure your van carefully to make sure the equipment you choose will fit properly.

2014 Transit Connect Packages coming soon on [www.weatherguard.com](http://www.weatherguard.com)

# ROOF RACK FITTING GUIDE



Full Size Vans								Compact Vans	
FORD	GM	NISSAN NV <sup>1</sup>		PROMASTER <sup>2</sup>		MERCEDES SPRINTER		TRANSIT CONNECT <sup>3</sup>	RAM CV
'92 & NEWER	'96 & NEWER	STANDARD ROOF	HIGH ROOF	STANDARD ROOF	HIGH ROOF	'07 & NEWER STD. ROOF	'07 & NEWER HIGH ROOF		
<b>EZ-GLIDE® SYSTEM RACK PAGES 42-43</b>									
251-3-02	X								
252-3-02		X							
253								X <sup>4</sup>	X
280-3-01			X		X		X		
285-3-01		X		X		X			
<b>ALUMINUM QUICK CLAMP RACKS PAGES 44-45</b>									
223-3								X	X
224-3								X	X
234-3	X	X							
236-3	X	X							
<b>ALUMINUM ALL-PURPOSE RACKS PAGE 46</b>									
209-3	X	X							
218-3								X	X
222-3									X
229-3	X	X							
2097-3	X	X							
<b>STEEL ALL-PURPOSE RACKS PAGE 46</b>									
205-3/205-5	X	X							
216-3/216-5	X	X							
2056-3/2056-5	X	X							
<b>SAFARI RACK PAGE 47</b>									
210-3	X	X							

1. Nissan mounting kit 2506 for High Roof, 2507 for Standard Roof.
2. PROMASTER mounting kits 2508 and 2508-01
3. 2010-2013 Transit Connect mounting kit 226-3-01 recommended
4. 2014 Transit Connect only

# Part Number Reference Guide

MODEL	DESCRIPTION	PAGE	MODEL	DESCRIPTION	PAGE	MODEL	DESCRIPTION	PAGE
205-3	All-Purpose Van Rack	46	8230-3-01	30" Welded Stack Unit	25	9344-3-02	REDZONE Van Shelf Unit (42" x 46" x 16")	22
205-5	All-Purpose Van Rack	46	8313-3-01	Lockable Cabinet	31	9345-3-02	REDZONE Van Shelf Unit (52" x 46" x 16")	22
2056-3	Accessory Cross Member	46	8316-3-01	4 Drawer Cabinet	31	9346-3-02	REDZONE Van Shelf Unit (60" x 46" x 16")	22
2056-5	Accessory Cross Member	46	8394-3-01	Special Order Shelf Unit (42" x 60" x 24")	22	9363-3-02	REDZONE Van Shelf Unit (36" x 62" x 16")	22
209-3	All-Purpose Van Rack	46	8394-3-01	Special Order Shelf Unit (52" x 60" x 24")	22	9364-3-02	REDZONE Van Shelf Unit (42" x 62" x 16")	22
2097-3	Accessory Cross Member	46	8395-3-01	Special Order Shelf Unit (69" x 60" x 24")	22	9365-3-02	REDZONE Van Shelf Unit (52" x 62" x 16")	22
210-3	Safari Rack	47	8401-3-01	EZ-Cube Dividers	25	9366-3-02	REDZONE Van Shelf Unit (60" x 62" x 16")	22
216-3	All-Purpose Van Rack	46	8502-3-01	EZ Shelf Door (42")	25	9380-3-02	Secure Shelf Unit (Door, 46" x 46" x 16")	24
216-5	All-Purpose Van Rack	46	8503-3-01	EZ Shelf Door (52")	25	9385-3-02	Secure Shelf Unit (5 dwrs, 46" x 46" x 16")	24
218-3	All-Purpose Van Rack Mini	46	88021	Ford Van Window Screen	33	9390-3-02	Secure Shelf Unit (Door, 62" x 46" x 16")	24
220-3	All-Purpose Van Rack Mini	46	88022	Ford Van Window Screen	33	9395-3-02	Secure Shelf Unit (5 dwrs, 62" x 46" x 16")	24
221-3	Accessory Cross Member	46	88023	Ford Van Window Screen	33	9400-3-01	EZ-Cube Shelf Unit (42" x 43.25" x 13.75")	25
222-3	Accessory Cross Member	46	88026	GM Van Window Screen	33	9444-3-01	42" Wheel Well Cabinet	25
223-3-01	Quick Clamp Rack Mini	45	88027	GM Van Window Screen	33	9452-3-01	EZ-Cube Shelf Unit (52" x 43.25" x 13.75")	25
224-3-01	Quick Clamp Rack Mini	45	88028	GM Van Window Screen	33	9503-3-01	Shelf Door, 36"	23
225-3	Accessory Cross Member	45	88040	Sprinter Van Window Screen	33	9504-3-01	Shelf Door, 42"	23
226-3-01	Mounting Bracket Ford Transit	45, 46	88041	Sprinter Van Window Screen	33	9505-3-01	Shelf Door, 52"	23
229-3	All-Purpose Van Rack	46	88042	RAM CV Van Window Screen	33	9506-3-01	Shelf Door, 60"	23
233-3-01	Accessory Cross Member	44	88043	RAM CV Van Window Screen	33	9603-3-01	Back Panel, 36"	23
234-3-01	Quick Clamp Rack	44	88044	RAM CV Van Window Screen	33	9604-3-01	Back Panel, 42"	23
236-3-01	Quick Clamp Rack	44	88045	Transit Connect Van Window Screen	33	9605-3-01	Back Panel, 52"	23
237	Conduit Carrier	47	88046	Transit Connect Van Window Screen	33	9606-3-01	Back Panel, 60"	23
238	Conduit Carrier Extension	47	88047	Transit Connect Van Window Screen	33	96101-3-01	Window Bulkhead Full Size Van	19
239	Conduit Carrier Kit	47	8841	EZ-Cube Shelf Mat	25	96102-3-01	Mesh Bulkhead Full Size Van	19
250	Sliding Ladder Rack	47	88530-5-01	Caravan Floor Covers	33	96111-3-01	Mesh Bulkhead Transit Connect	19
2501	Accessory Warning Light Holder	43	8866	Fire Extinguisher	18, 29	96115-3-01	Mesh Bulkhead RAM C/V	19
2502	Accessory Mirror Holder	43	8867-3-01	42" Work Top	31	96121-3-01	Window Bulkhead Sprinter	19
2503	Accessory Velcro Straps	43	8873-3-01	Extension Cord Brackets	29	96141-3-01	Window Bulkhead Promaster	19
2504	Accessory Mirror	43	8875	Hard Hat Bracket	18, 29	96142-3-01	Screen Bulkhead Promaster	19
2505	KUV Mounting Bracket	43	8877-3	Practice Holder	18	96201-3-01	Bulkhead High Roof, Nissan NV	19
2506	Ladder Rack Mounting Kit	43	8908-3	Special Order Parts Cabinet	30	96511-3-01	Window Bulkhead Transit Connect	19
2507	Ladder Rack Mounting Kit	43	8931-3	Special Order Parts Cabinet	30	96515-3-01	Window Bulkhead RAM C/V	19
251-3-02	EZ-GLIDE® System (Ford)	42	89011	Universal Floor Mat	33	96901-3-01	Door Conversion Kit	18, 19
2511	Accessory Cross Member	43	89015	GM Floor Mat	33	96903-3-01	Solid Panel Kit	18, 19
252-3-02	EZ-GLIDE® System (GM)	42	89017	Ford Floor Mat	33	9703-3-01	Retainer Lip, 36"	29
2521	Accessory Cross Member	43	9012-3-01	Cab Command Center	32	9704-3-01	Retainer Lip, 42"	29
253	EZ-GLIDE® System (Mini-van)	42	9020-3-01	Locking Cabinet	31	9705-3-01	Retainer Lip, 52"	29
2531	EZ-GLIDE® Accessory Cross Member	43	9021-3-01	Locking Cabinet With Shelf	31	9706-3-01	Retainer Lip, 60"	29
254	EZ-GLIDE® Drivers Side Clamp Kit	43	9029-3-01	Open Cabinet With Bin	31	9720-3-01	Nissan Floor Mounting Kit	23
255	EZ-GLIDE® Drivers Side Drop Down	42	9036-3	Strong Box	33	9730-3-01	Shelf Support, 36"	23
280-3-01	EZ-GLIDE® System (High Roof)	43	9040-3-01	Lockable Secure Storage Module	23, 24	9740-3-01	Shelf Support, 46"	23
281	EZ-GLIDE® System (Cube van)	43	9045-3-01	5 Drawer Secure Storage Module	23, 24	9760-3-01	Shelf Support, 62"	23
282	EZ-GLIDE® System (Cube van)	43	9103-3-01	STARTER 2 Shelf Set (36" x 13")	23	9822-3-01	Drawer Divider, Standard	30
283	EZ-GLIDE® System (Cube van)	43	9104-3-01	STARTER 3 Shelf Set (42" x 16")	23	9823	Shelf Divider, 13"	23
284	EZ-GLIDE® System (Cube van)	43	9105-3-01	STARTER 3 Shelf Set (52" x 16")	23	9824-3-01	Drawer Divider, Tall	30
285-3-01	EZ-GLIDE® System (Standard Roof)	43	9106-3-01	STARTER 3 Shelf Set (60" x 16")	23	9826	Shelf Divider, 16"	23
286-3-01	Drivers Side Drop Down (High Roof)	42	9107-3-01	STARTER 4 Shelf Set (42" x 16")	23	9832	Shelf Mat, 13"	29
287-3-01	Drivers Side Drop Down (Standard Roof)	42	9108-3-01	STARTER 4 Shelf Set (52" x 16")	23	9836	Small Bin Set (9 bins)	29
301-3	PACK RAT® Drawer Unit (30" x 12.5" x 24")	37	9109-3-01	STARTER 4 Shelf Set (60" x 16")	23	9855-7-01	Medium Bin Set (6 bins)	29
303-3	PACK RAT® Drawer Unit (39.5" x 12.5" x 24")	37	9133-3-01	Shelf Narrow Short	23	9856-7-01	Large Bin Set (3 bins)	29
304-3	PACK RAT® Drawer Unit (30" x 9" x 48")	37	9134-3-01	Shelf Narrow Std	23	9860-3-01	Catalog File Unit	31
305-3	PACK RAT® Drawer Unit (10.25" x 9" x 48")	37	9135-3-01	Shelf Narrow Xtd	23	9861-3-01	Rack, Cable Reel (Floor Mount)	31
306-3	PACK RAT® Drawer Unit (20" x 9" x 48")	37	9136-3-01	Shelf Narrow Long	23	9862-3-01	Rack, Freon Tank 3 x 50"	31
307-3	PACK RAT® Drawer Unit (30" x 9" x 48")	37	9163-3-01	Shelf Std Short	23	9863-3-01	Rack, Freon Tank 2 x 30", 50"	31
308-3	PACK RAT® Drawer Unit (39.75" x 9" x 48")	37	9164-3-01	Shelf Std Std	23	9864-3-01	Rack, Freon Tank 4 x 30"	31
308-5	PACK RAT® Drawer Unit (39.75" x 9" x 48")	37	9165-3-01	Shelf Std Xtd	23	9871-3-01	Door Organizer (Trays)	32
310-3-01	PACK RAT® Drawer Unit (12.5" x 17.75" x 42")	36, 37	9166-3-01	Shelf Std Long	23	9872-3-01	Door Organizer (Open)	32
3100	BED RAT® Sliding Platform	39	9173-3-01	REDZONE 2 Shelf Set (36" x 13")	23	9873-3-01	Door Organizer (Tool Holder)	32
312-3	PACK RAT® Drawer Unit (30" x 9" x 24")	37	9174-3-01	REDZONE 2 Shelf Set (42" x 13")	23	9874-7-01	Can Organizer	28
314-3	ITEMIZER® Drawer Unit	34	9175-3-01	REDZONE 2 Shelf Set (52" x 13")	23	9878-7-01	Cleaning Station	28
316-3	ITEMIZER® Drawer Unit (2 lateral)	34	9176-3-01	REDZONE 2 Shelf Set (60" x 13")	23	9879-7-01	Tool Organizer	18, 28
317-3	ITEMIZER® Drawer Unit (3 lateral)	34	9183-3-01	REDZONE 3 Shelf Set (36" x 16")	23	9880-3-01	Literature Holder	29, 32
318-3	ITEMIZER® Drawer Unit (4 lateral)	34	9184-3-01	REDZONE 3 Shelf Set (42" x 16")	23	9881-7-01	Caulk Tube Holder	28
3200	BED RAT® Sliding Platform	39	9185-3-01	REDZONE 3 Shelf Set (52" x 16")	23	9882-7-01	Wire Spool Holder (End Mount)	28
326-3	ITEMIZER® Drawer Unit (2 stacked)	34	9186-3-01	REDZONE 3 Shelf Set (60" x 16")	23	9906-3-01	Parts Cabinet 6 Bin	30
327-3	ITEMIZER® Drawer Unit (3 stacked)	34	9193-3-01	REDZONE 4 Shelf Set (36" x 16")	23	9909-3-01	Parts Cabinet 9 Bin	30
328-3	ITEMIZER® Drawer Unit (4 stacked)	34	9194-3-01	REDZONE 4 Shelf Set (42" x 16")	23	9912-3-01	2 Drawer Cabinet	30
334-3	PACK RAT® Drawer Unit (30" x 12.5" x 48")	33	9195-3-01	REDZONE 4 Shelf Set (52" x 16")	23	9914-3-01	4 Drawer Cabinet	30
335-3	PACK RAT® Drawer Unit (10.25" x 12.5" x 48")	33	9196-3-01	REDZONE 4 Shelf Set (60" x 16")	23	9918-3-01	Parts Cabinet 18 Bin	30
336-3	PACK RAT® Drawer Unit (20" x 12.5" x 48")	33	9203-3-01	STARTER End Panel Set (34"H x 13"D)	23	9924-3-01	4 Drawer Tall Cabinet	30
337-3	PACK RAT® Drawer Unit (30" x 12.5" x 48")	33	9204-3-01	STARTER End Panel Set (44"H x 13"D)	23	9928-3-01	8 Drawer Tall Cabinet	30
338-3	PACK RAT® Drawer Unit (39.75" x 12.5" x 48")	33	9206-3-01	STARTER End Panel Set (60"H x 13"D)	23	9950-7-01	Parts Box Cabinet	30
338-5	PACK RAT® Drawer Unit (39.75" x 12.5" x 48")	33	9233-3-01	REDZONE End Panel Set (36"H x 13"D)	23	9951-9-01	Parts Box	30
3400	BED RAT® Sliding Platform	39	9264-3-01	REDZONE End Panel Set (46"H x 13"D)	23	9953-7-01	Grab & Go Tool Cart	28
70202	Quick Release Handle Kit	23, 29	9266-3-01	REDZONE End Panel Set (62"H x 13"D)	23	9992-3-01	Top Shelf (42" w x 13" d)	23
70206-XX	Replacement Lock Kit	24	9333-3-02	REDZONE Van Shelf Unit (36" x 36" x 13")	22			
70210-XX	Key Alike Kit	24	9334-3-02	REDZONE Van Shelf Unit (42" x 36" x 13")	22			
70211-XX	Replacement Handle Kit	24	9336-3-02	REDZONE Van Shelf Unit (60" x 36" x 13")	22			
8118-3-01	Shelf Dividers (24")	22	9343-3-02	REDZONE Van Shelf Unit (26" x 46" x 16")	22			





DISTRIBUTED BY:



MAXIMUM ORGANIZATION AND PRODUCTIVITY  
Maximum Organization and Productivity

UNMATCHED DURABILITY AND RELIABILITY  
Unmatched Durability and Reliability

INDUSTRY-LEADING SECURITY  
Industry-Leading Security



**LIMITED LIFETIME WARRANTY**

Knaack LLC (the Manufacturer) warrants to the original purchaser, only, that WEATHER GUARD® van products (the "WEATHER GUARD Product") will be free from defects in material and workmanship from the date of purchase and continuing for the expected lifetime of the WEATHER GUARD Product. Please call our customer service department toll free at 1.800.456.7865 with any questions or comments.

DO NOT use these products for storing or transporting flammables, explosives, hazardous materials or waste, such as gasoline, solvents, gun powder, dynamite, gases or any tanks, torches or gas powered equipment. These products are intended and safe for storing and transporting small tools and other non-combustible, non-flammable materials. Any modification made to, or unintended use of, these products may create a dangerous condition causing death, serious bodily injury or property damage.

**NOTICE**

Any modification or unintended use of these products shall immediately void all manufacturers warranties. Manufacturer disclaims all liability for injuries to persons or property resulting from any modification to, or unintended use of these products.

Ford Transit Connect, Nissan NV, Mercedes Sprinter, and Dodge RAM CV are registered trademarks of their respective owners.

**For more information:**

**US – visit [www.weatherguard.com](http://www.weatherguard.com) or call 800.456.7865**

**CANADA – visit [www.weatherguard.ca](http://www.weatherguard.ca) or call 888.562.2251**

